

PLINTH CORNER PART

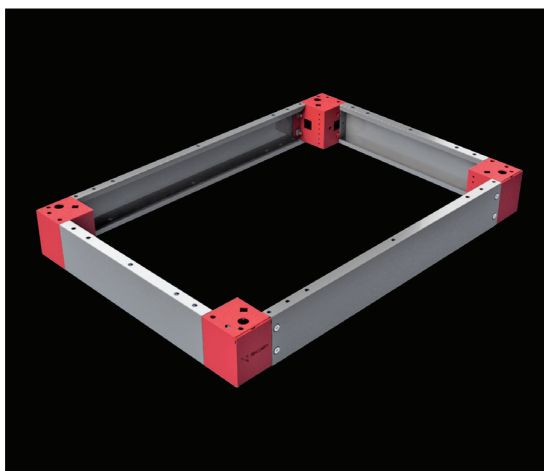

Relevance : TEOS, NEO Modular, NEO Monoblock, NEO HC Modular, NEO HC Monoblock

Related size : PLINTH HEIGHT

Material : Corner part : 2,00 mm galvanized steel + RAL 7012 powder-coating
Plastic Panel : RAL 7012 ABS Plastic

Supply Includes : 4 pcs 100 mm or 200 mm high plinth corner part, 4 pcs plastic panel and mounting parts

NOTE : Please see page 154-155 for plinth accessories.

PRODUCT CODE	TEOS PLINTH HEIGHT (mm)
708.100	100
708.200	200

PLINTH FRONT COVERS

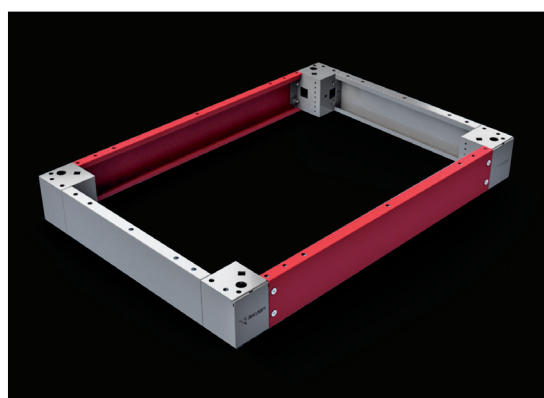

Relevance : TEOS, NEO Modular, NEO Monoblock, NEO HC Modular, NEO HC Monoblock

Related size : ENCLOSURE WIDHT

Material : 100 mm front plinth part: 1,50 mm galvanized steel + RAL 7012 powder-coating

Supply Includes : 2 pcs 100 mm front plinth part and mounting parts

REQUIRED : 2 sets of front plinth panel group for 200 mm height plinths

PRODUCT CODE	ENCLOSURE WIDHT (mm)
709.140	400
709.160	600
709.170	700
709.180	800
709.100	1000
709.120	1200

PLINTH SIDE COVERS

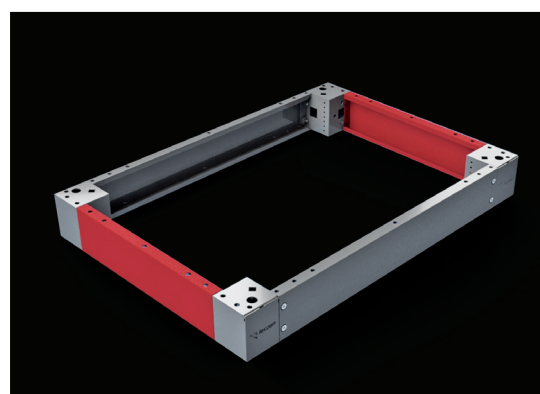

Relevance : TEOS, NEO Modular, NEO Monoblock, NEO HC Modular, NEO HC Monoblock

Related size : ENCLOSURE WIDHT

Material : 100 mm side plinth part: 1,50 mm galvanized steel + RAL 7012 powder-coating

Supply Includes : 2 pcs 100 mm front plinth part and mounting parts

REQUIRED : 2 sets of front plinth panel group for 200mm height plinths

PRODUCT CODE	ENCLOSURE WIDHT (mm)
710.140	400
710.150	500
710.160	600
710.180	800
710.100	1000

PLINTH and PLINTH PARTS

FIXED PLINTH

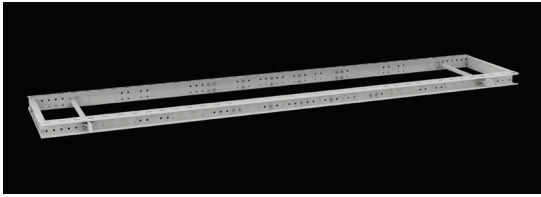

Relevance : TEOS, NEO Modular

Material : 3,00 mm / galvanized steel + RAL 7012 coating

Supply Includes : Plinth width : 2 pcs plinth and combination parts.
Plinth depth : 2 pcs plinth and combination parts.



REQUIRED : It is required M12x30 screw set for fixing (page 259)

- Mounts the enclosures combined side-to-side on a single platform.
- Enclosures are connected to the plinth via M12 perforations placed on the combination corners.
- It gives advantages in the lifting and forklift.
- Enclosures can be mounted directly on the (standard) plinth.
- Please refer to our sales department for the manufacturing schedule.



PRODUCT CODE	PLINTH WIDHT (mm)	PRODUCT CODE	PLINTH WIDHT (mm)
912.100	1800	912.111	2900
912.101	1900	912.112	3000
912.102	2000	912.113	3100
912.103	2100	912.114	3200
912.104	2200	912.115	3300
912.105	2300	912.116	3400
912.106	2400	912.117	3500
912.107	2500	912.118	3600
912.108	2600	912.119	3700
912.109	2700	912.120	3800
912.110	2800	912.121	3900

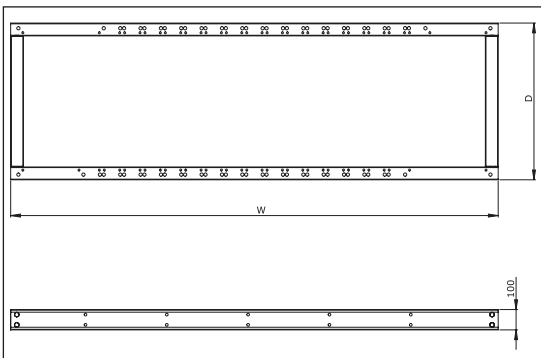

PRODUCT CODE	PLINTH WIDHT (mm)	PRODUCT CODE	PLINTH WIDHT (mm)
912.133	400	912.122	4000
912.134	500	912.123	4100
912.135	600	912.124	4200
912.136	800	912.125	4300
		912.126	4400
		912.127	4500
		912.128	4600
		912.129	4700
		912.130	4800
		912.131	4900
		912.132	5000

M12 LEVELING FEET



Relevance : TEOS, NEO Modular, NEO Monoblock

Supply Includes : 4 pcs M12 Leveling Feet

Product code : 995.510

BLOCK PLINTH

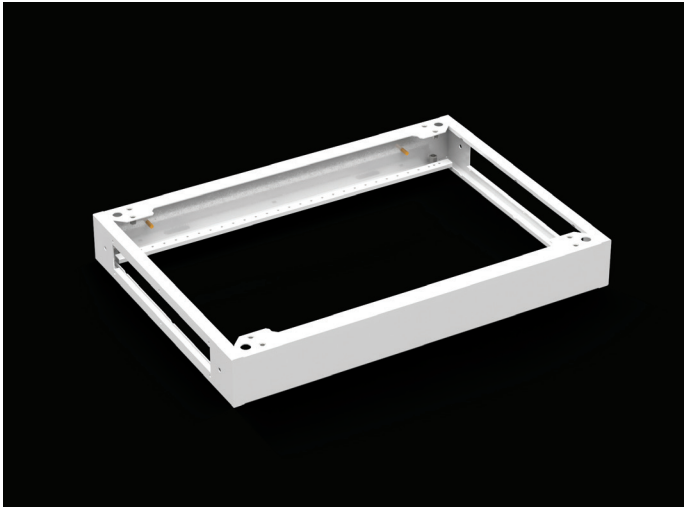

Relevance TEOS, NEO Modular, NEO Monoblock, NEO HC Modular, NEO HC Monoblock

Related Size Width X Depth

Material 2mm Galvanized + RAL 7035

Supply Includes Welded Block PLINTH

Easy movement apparatus on the ground

PLINTH mounting bolt equipment

Product Description The ability of fixing plinths to each other in process of combining enclosures.



PRODUCT CODE		
100 H	200 H	ENCLOSURE DIMENSIONS
915.146	915.246	400 W x 600 D
915.148	915.248	400 W x 800 D
915.164	915.264	600 W x 400 D
915.166	915.266	600 W x 600 D
915.168	915.268	600 W x 800 D
915.176	915.276	700 W x 600 D
915.178	915.278	700 W x 800 D
915.184	915.284	800 W x 400 D
915.186	915.286	800 W x 600 D
915.188	915.288	800 W x 800 D
915.116	915.216	1000 W x 600 D
915.118	915.218	1000 W x 800 D
915.124	915.224	1200 W x 400 D
915.126	915.226	1200 W x 600 D
915.128	915.228	1200 W x 800 D

BLOCK PLINTH SIDE PANEL

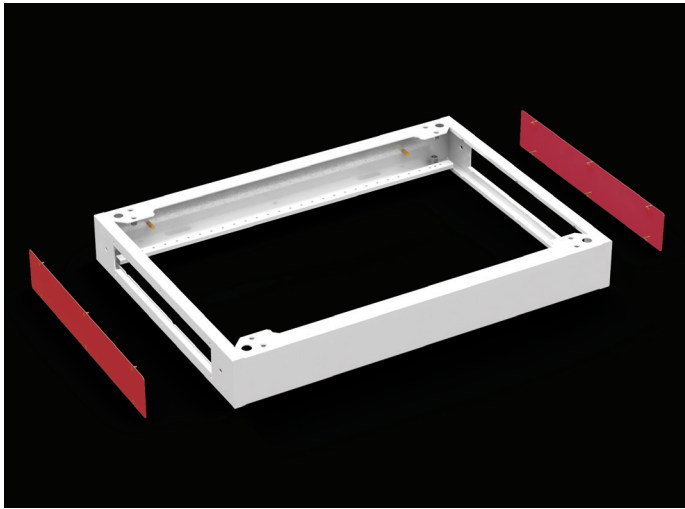

Material 1,5mm Galvanized + RAL 7035

Supply Includes 2 Pcs 100mm / 200mm H PLINTH Side Cover
 PLINTH Side Cover Bolt Accessory
 PLINTH mounting bolt equipment

PRODUCT CODE		ENCLOSURE DIMENSIONS
100 H	200 H	
916.140	916.140	400 D
916.160	916.160	600 D
916.180	916.180	800 D

BLOK PLINTH GLANT PLATE

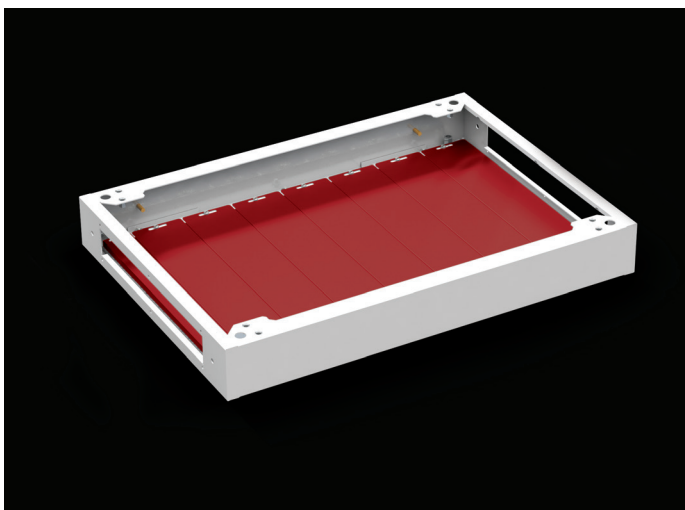

Material 1,5mm Galvanized

Supply Includes 1 Pcs 55mm / 100mm width glant plate
 PLINTH Gland Plate Bolt Accessory

PRODUCT CODE		ENCLOSURE DIMENSIONS
55 W	100 W	
721.040	722.040	400 D
721.060	722.060	600 D
721.080	722.080	800 D

PRODUCT DIMENSIONS	55 W (Pcs)	100 W (Pcs)
400 W x 600 D - 100 H / 200 H	1	3
400 W x 800 D - 100 H / 200 H	1	3
600 W x 400 D - 100 H / 200 H	1	5
600 W x 600 D - 100 H / 200 H	1	5
600 W x 800 D - 100 H / 200 H	1	5
700 W x 600 D - 100 H / 200 H	1	6
700 W x 800 D - 100 H / 200 H	1	6
800 W x 400 D - 100 H / 200 H	1	7
800 W x 600 D - 100 H / 200 H	1	7
800 W x 800 D - 100 H / 200 H	1	7
1000 W x 600 D - 100 H / 200 H	1	9
1000 W x 800 D - 100 H / 200 H	1	9
1200 W x 400 D - 100 H / 200 H	1	11
1200 W x 600 D - 100 H / 200 H	1	11
1200 W x 800 D - 100 H / 200 H	1	11

FOAM RUBBER CABLE ENTRY SYSTEM

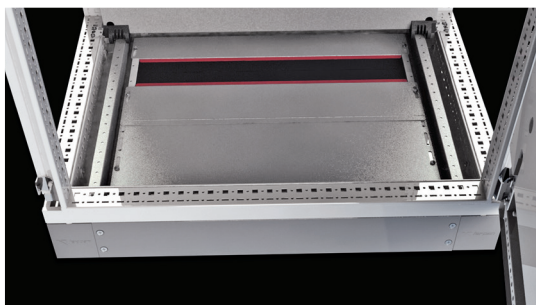

Relevance : TEOS, NEO Modular, NEO HC Modular

Related Size : ENCLOSURE WIDTH

Material : Polyurethane foam

Supply Includes : Polyurethane foam, combination profile and parts

NOTE : 2 accessories per (1000mm and 1200mm wide) foam entry system

PRODUCT CODE	ENCLOSURE WIDTH (mm)
923.400	400
923.600	600
923.700	700
923.800	800
923.100	1000*
923.120	1200*

BRUSHED CABLE ENTRY SYSTEM

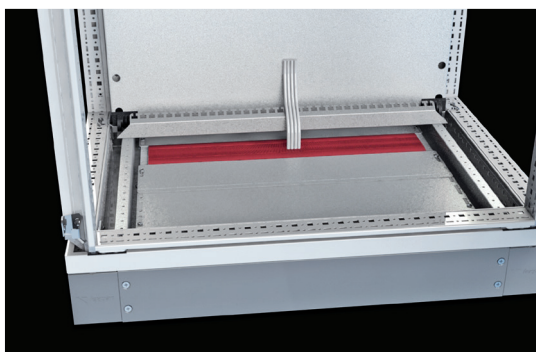

Relevance : TEOS, NEO Modular, NEO HC Modular

Related size : ENCLOSURE WIDTH

Material : ABS plastic

Supply Includes : Strip brush, combination profile and parts

NOTE : 2 accessories per (1000mm and 1200mm wide) brush entry system

PRODUCT CODE	ENCLOSURE WIDTH (mm)
923.401	400
923.601	600
923.701	700
923.801	800
923.101	1000*
923.121	1200*

CABLE CLAMP RAIL (CLIP-ON)

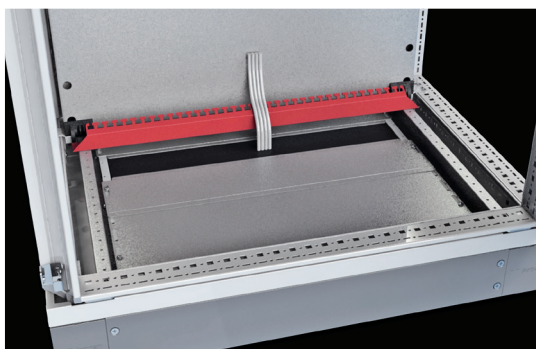

Relevance : TEOS, NEO Modular, NEO Monoblock, NEO HC Modular, NEO HC Monoblock

Related size : ENCLOSURE WIDTH

Material : 2,00 mm mild steel + zinc-plating

Supply Includes : Cable bracket combination profile and combination parts.

PRODUCT CODE	ENCLOSURE WIDTH (mm)
998.400	400
998.600	600
998.700	700
998.800	800
998.100	1000
998.120	1200

ASSEMBLING and LIFTING PARTS

BAYING KIT

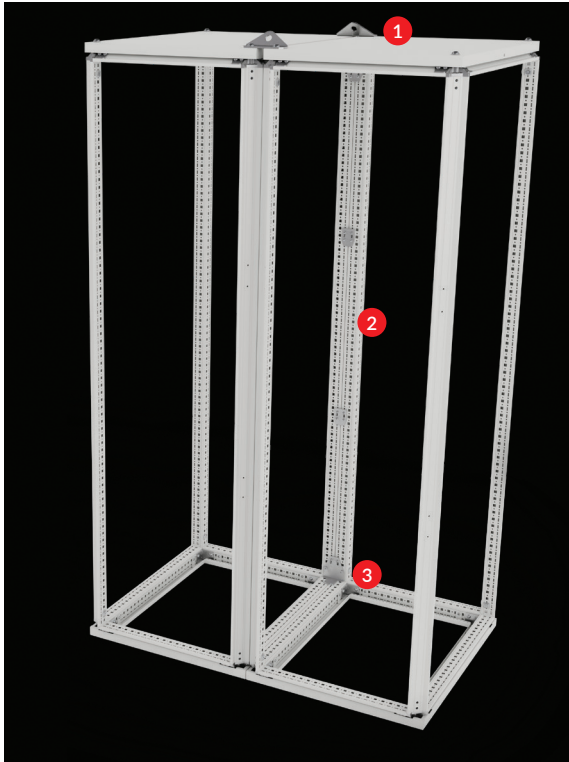

Relevance : TEOS

Material : 3,00 mm - 4,00 mm mild steel parts zinc coated + galvanized

Supply Includes : 2 pcs combination angles, 4 pcs angular brackets, 2 pcs adjustable bracket, 4 pcs fixing bracket, 5,60 insulation gasket and mounting parts

Product Code : 711.000

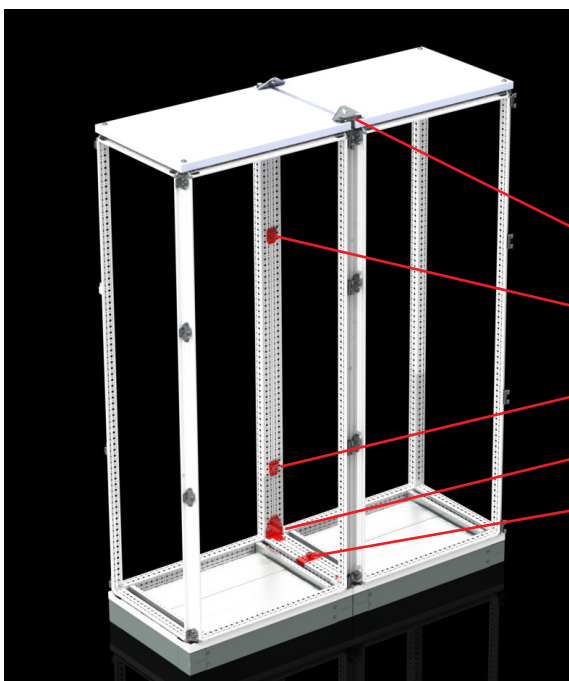
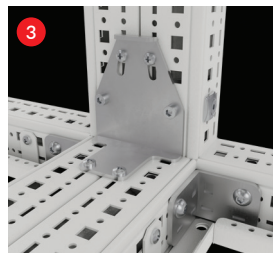

1-) 2x Combination angles. Product Code: **711.001** (2 pcs)

2-) 4x Fixing bracket. Product Code: **711.002** (4 pcs)

3-) 4x angular brackets. Product Code: **711.003** (4 pcs)

4-) 2x adjustable bracket. Product Code: **711.004** (2 pcs)

5-) 5,60 m 10x3 gasket. Product Code: **992.100** (page 205)

BAYING KIT

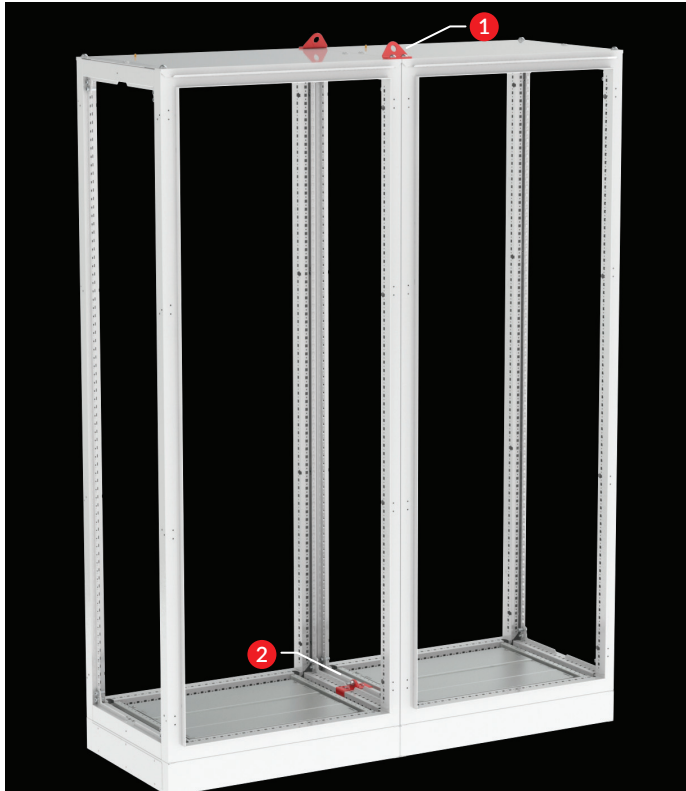

Relevance : NEO Modular, NEO HC Modular

Material : 3,00 mm - 4,00 mm mild steel parts zinc coated + galvanized

Supply Includes : 2 pcs combination angles **1**
8 Pcs M6 assembling screw and nuts
4 pcs angular brackets **2**
5.6 m insulation gasket and mounting parts

Product Code : 611.000

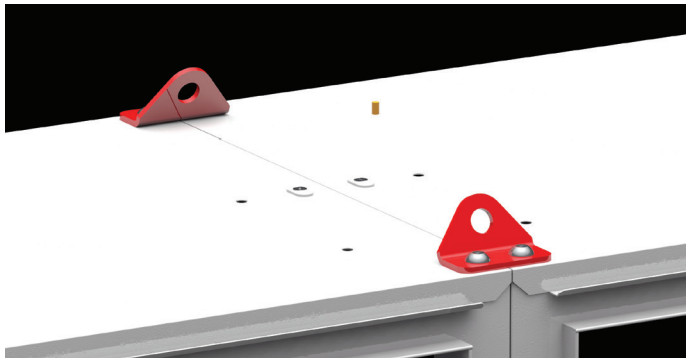

ASSEMBLING and LIFTING PARTS

M12 EYEBOLT CARRIER



Relevance : TEOS, NEO Monoblock, NEO Modular,
NEO HC Monoblock, NEO HC Modular

Materials : Carbon Steel + Electro-Galvanized Coating

Supply Includes: 4 x Eyebolts and Enclosure Assembling Parts

Product Code : 612.000

FIXING WALL RAIL

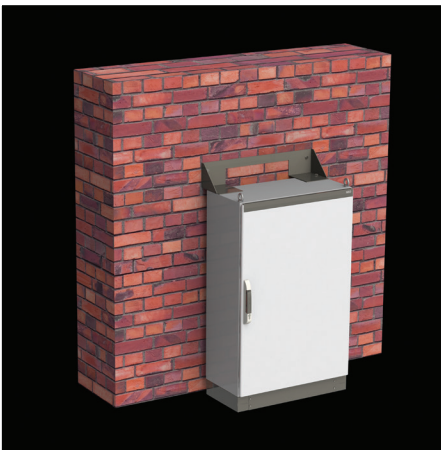

Relevance : NEO Monoblock

Material : 4,00 mm mild steel + RAL 7035
powder coating

Supply Includes : 2 pcs rail and assembling parts

PRODUCT CODE	ENCLOSURE WIDTH (mm)
972.600	600
972.800	800
972.100	1000
972.120	1200

ATTENTION : The wall fixing option is only available for 1200-height panels. It can be used as wall support with base in other height panels.

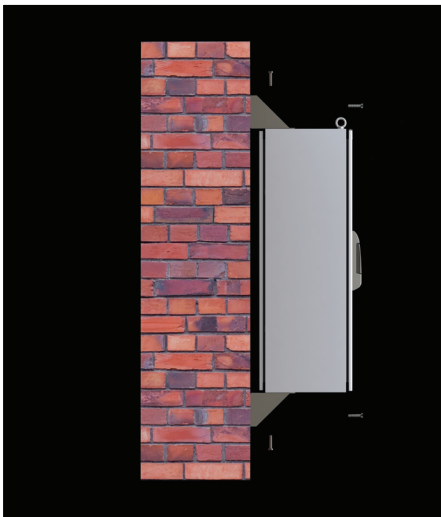



TOP ANGLE IRON COMBINATION

Relevance : TEOS

Material : 60x60 mm x 5 mm + RAL 7012 coating

Supply Includes : 2 length angle bending

Required : 4 pcs M12x30 screw set is required for each enclosure.

▼ This connection type is particularly used for heavy enclosure combination and support applications. Do the supporting in accordance with supporting instructions.

▼ Please refer to our sales department for the manufacturing schedule.

PRODUCT CODE	ANGLE BRACKET WIDTH (mm)
912.137	1800
912.138	1900
912.139	2000
912.140	2100
912.141	2200
912.142	2300
912.143	2400
912.144	2500
912.145	2600
912.146	2700
912.147	2800

PRODUCT CODE	ANGLE BRACKET WIDTH (mm)
912.148	2900
912.149	3000
912.150	3100
912.151	3200
912.152	3300
912.153	3400
912.154	3500
912.155	3600
912.156	3700
912.157	3800
912.158	3900

PRODUCT CODE	ANGLE BRACKET WIDTH (mm)
912.159	4000
912.160	4100
912.161	4200
912.162	4300
912.163	4400
912.164	4500
912.165	4600
912.166	4700
912.167	4800
912.168	4900
912.169	5000



CORNER ENCLOSURE

Relevance : TEOS

- Designed for enclosures when enclosures are combined as an L. Door opening has been increased by means of door suspending adapter.
- Use the table below for corner enclosure options. Bottom-top plinth frame and vertical frame group are standard. Only the panel set and adapter group is chosen in accordance with enclosure depth.
- Inner enclosure applications and panel combination parts can be applied as standard.

	PRODUCT CODE	ENCLOSURE DIMENSION	
		Height (mm)	Depth (mm)
ADAPTER PART	933.000	1800	600
	933.001	1800	800
	933.002	2000	600
	933.003	2000	800
PANEL SET (2 PCS)	933.004	1800	600
	933.005	1800	800
	933.006	2000	600
	933.007	2000	800

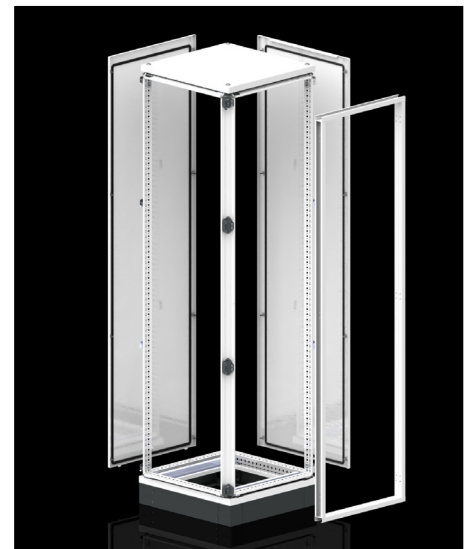

MOUNTING PLATE (3 mm thickness)



Material:

3,00 mm galvanized steel

Supply Includes :

1 pcs mounting plate and assembling parts

Width (mm)	Height (mm)			
	1200	1800	1600	2000
400	-	-	707.418	707.420
600	707.612	707.616	707.618	707.620
700	-	-	-	707.720
800	707.812	707.816	707.818	707.820
1000	-	-	707.018	707.020
1200	-	-	707.218	707.220

MOUNTING PLATES (2 mm thickness)



Material:

2,00 mm galvanized steel

Supply Includes :

1 pcs mounting plate and assembling parts

Width (mm)	Height (mm)			
	1200	1800	1600	2000
400	-	-	717.418	717.420
600	717.612	717.616	717.618	717.620
700	-	-	-	717.720
800	717.812	717.816	717.818	717.820

MOUNTING RAIL and MOUNTING PLATE

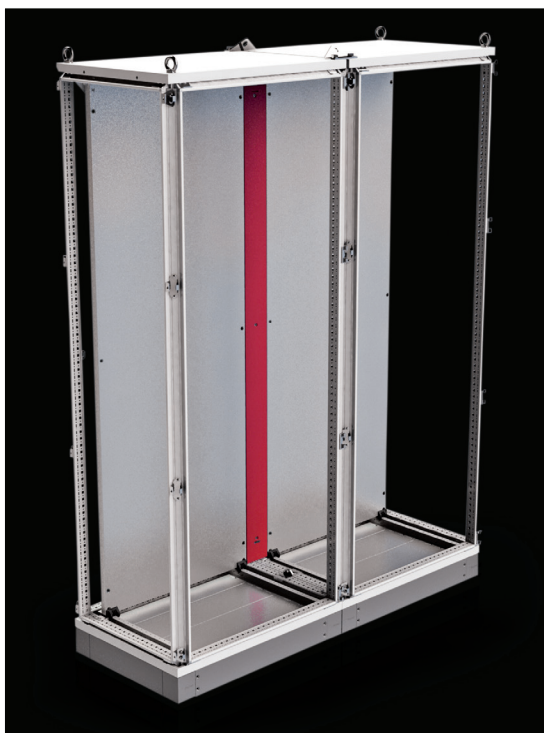

INTERMEDIATE MOUNTING PLATE

Relevance : TEOS, NEO Modular, NEO HC Modular,

Related size : ENCLOSURE WIDTH

Material : 2,00 mm galvanized steel

Supply Includes : 1 pcs mounting plate, 3 pcs bracket and assembling parts.

PRODUCT CODE	ENCLOSURE WIDTH (mm)
712.120	1200
712.160	1600
712.180	1800
712.200	2000
712.220	2200



MOUNTING PLATE FOR CORNER EXTENSION

Relevance : TEOS, NEO Modular, NEO Monoblock, NEO HC Modular, NEO HC Monoblock,

Material : 2,00 mm galvanized steel

Supply Includes : 2 pcs extension part and assembling parts

PRODUCT CODE	ENCLOSURE HEIGHT (mm)
712.121	1200
712.161	1600
712.181	1800
712.201	2000
712.221	2200



SHORT MOUNTING PLATE APPLICATION

Relevance : TEOS, NEO Modular, NEO Monoblock, NEO HC Modular, NEO HC Monoblock,

- Depth rails allow for use of shorter mounting plates inside the enclosure. Thereby, this allows for busbar support and busbar applications on the mounting plate.
- Each mounting plate needs 2 pcs depth rails and 4 pcs brackets. Please see page 167-169 for related products.
- Please see page 210-231 for busbar support needs.

ATTENTION : There is no inconvenience in using intermediate mounting plates and corner extension parts for short mounting plate applications. It can move front to back with these accessories

MOUNTING RAIL and MOUNTING PLATE

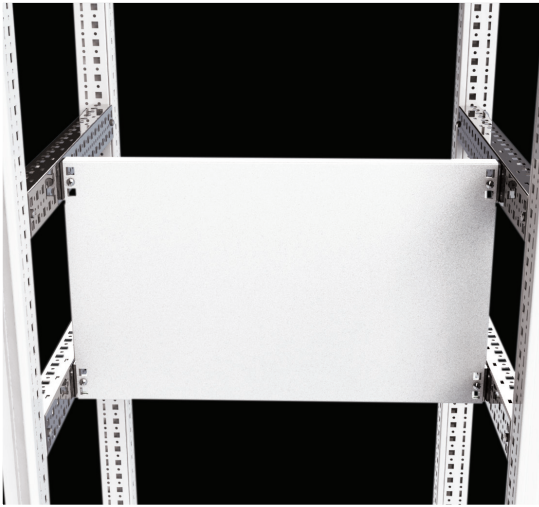

PARTIAL MOUNTING PLATE

Relevance : TEOS, NEO Modular, NEO Monoblock, NEO HC Modular, NEO HC Monoblock,

Material : 2,00 mm galvanized steel.

Supply Includes : 1 pcs. mounting plate

REQUIRED : 4 pcs plug-in rail bracket required for mounting the mounting plate. Page 96
 Product Code: **944.420** (100 pcs.) (Screws included)
944.421 (12 pcs.) (Screws included)



Application on MCCB kit, page 172



Application on enclosure frame

PRODUCT CODE	ENCLOSURE WIDTH(mm)	PLATE NET WIDTH(mm)	PLATE NET HEIGHT(mm)	PACKS OF
944.442	400	295	150	1
944.443	400	295	175	1
944.444	400	295	200	1
944.445	400	295	250	1
944.446	400	295	300	1
944.447	400	295	400	1
944.448	400	295	500	1
944.449	400	295	600	1
944.450	500	395	400	1
944.451	600	495	150	1
944.452	600	495	175	1
944.453	600	495	200	1
944.454	600	495	250	1
944.455	600	495	300	1
944.456	600	495	400	1
944.457	600	495	500	1
944.458	600	495	600	1
944.459	700	595	150	1
944.460	700	595	175	1
944.461	700	595	200	1
944.462	700	595	250	1
944.463	700	595	300	1
944.464	700	595	400	1
944.465	700	595	500	1
944.466	700	595	600	1
944.467	800	695	150	1
944.468	800	695	175	1
944.469	800	695	200	1
944.470	800	695	250	1
944.471	800	695	300	1
944.472	800	695	400	1
944.473	800	695	500	1
944.474	800	695	600	1
944.475	1000	895	175	1
944.476	1000	895	200	1
944.477	1000	895	250	1

MOUNTING RAIL and MOUNTING PLATE

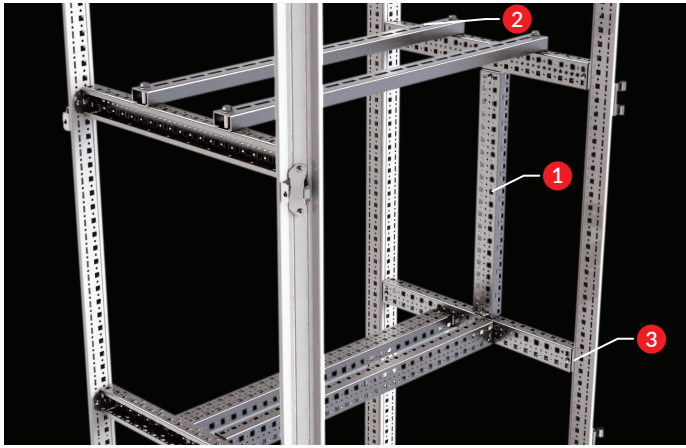

1 SCISSILE RAIL (P. 167)

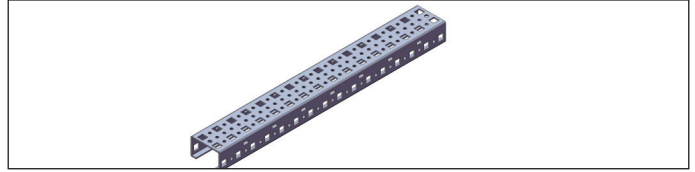

2 HEAVY EQUIPMENT PROFILE (P. 168)

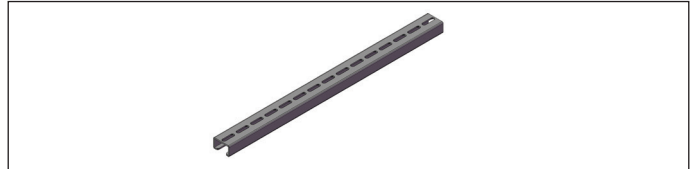

3 PLUG IN RAIL BRACKET (P. 169)

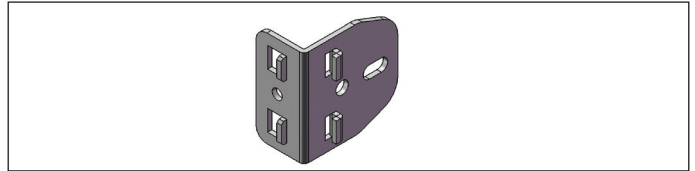

4 ADJUSTABLE RAIL BRACET (P. 170)

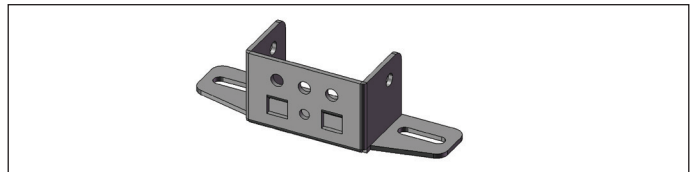

5 ADJUSTABLE RAIL BRACET (P. 171)

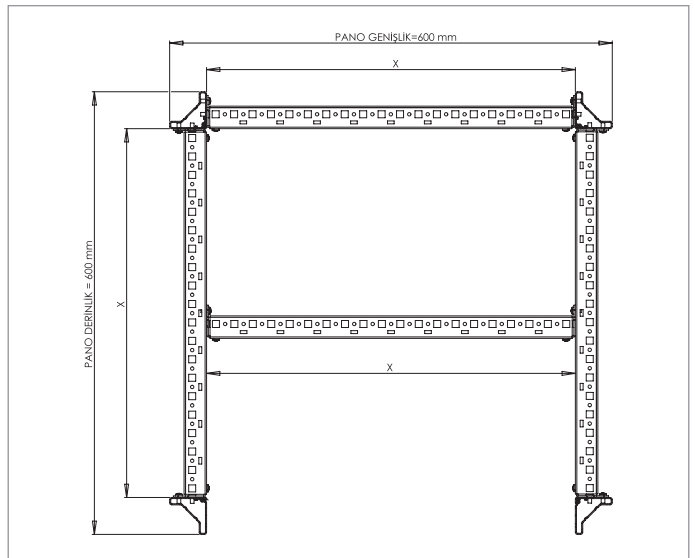
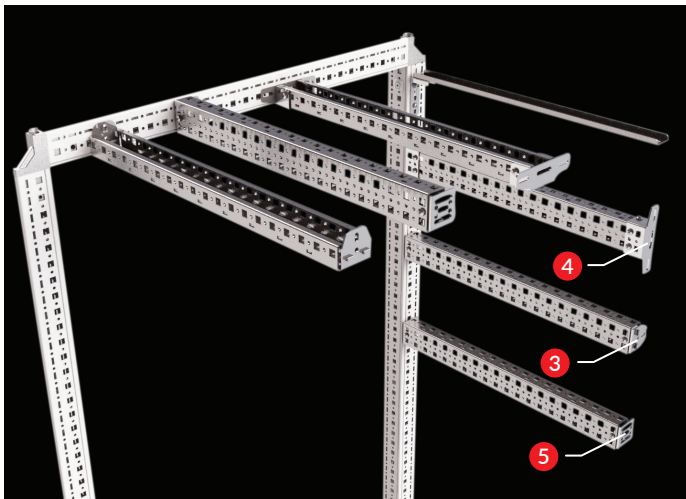
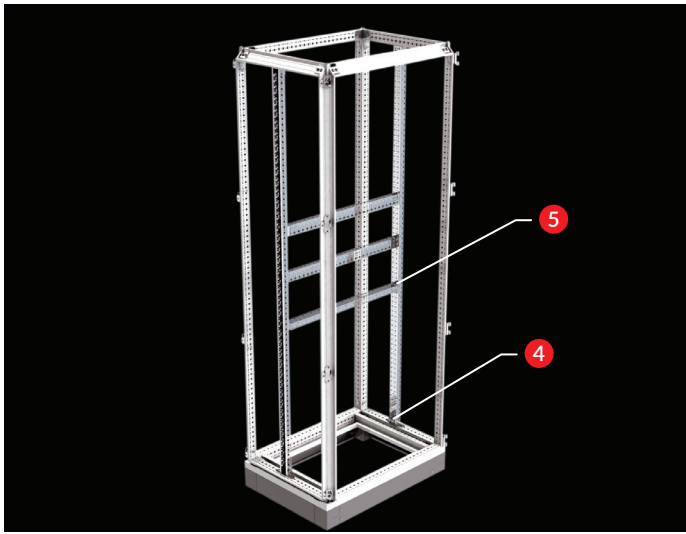
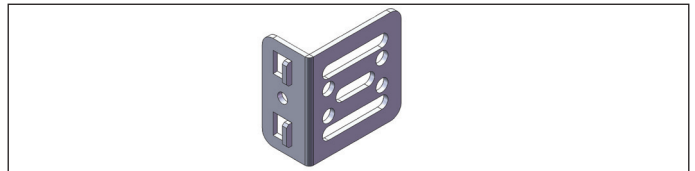

In terms of both width and interior depth size, TEOS body structure is designed at the same coefficient rate. The complete structure inside the body is designed at the 25mm coefficient. Thus, the width rail can also be installed on the depth rail.

MOUNTING RAIL and MOUNTING PLATE

SCISSILE RAIL SYSTEM (50x25 cross-section)

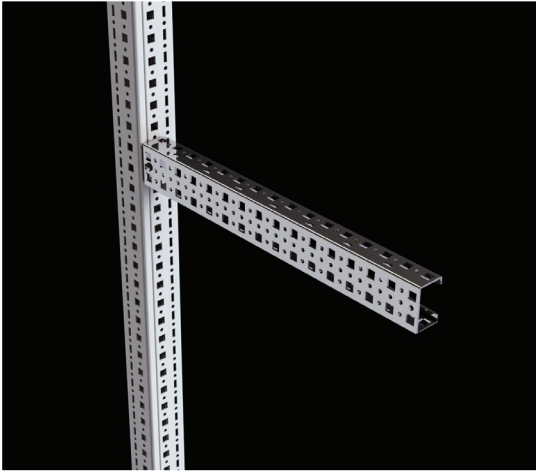

Relevance : TEOS, NEO Modular, NEO Monoblock, NEO HC Modular, NEO HC Monoblock,

Material: 2.00 mm Mild steel + zinc coated

Supply Includes : In product pack there is only rail included. Please be check quantities of rails in pack on sheet below

REQUIRED : There is brackets required to assemble rail. Please see page 169-171

Cut -off point

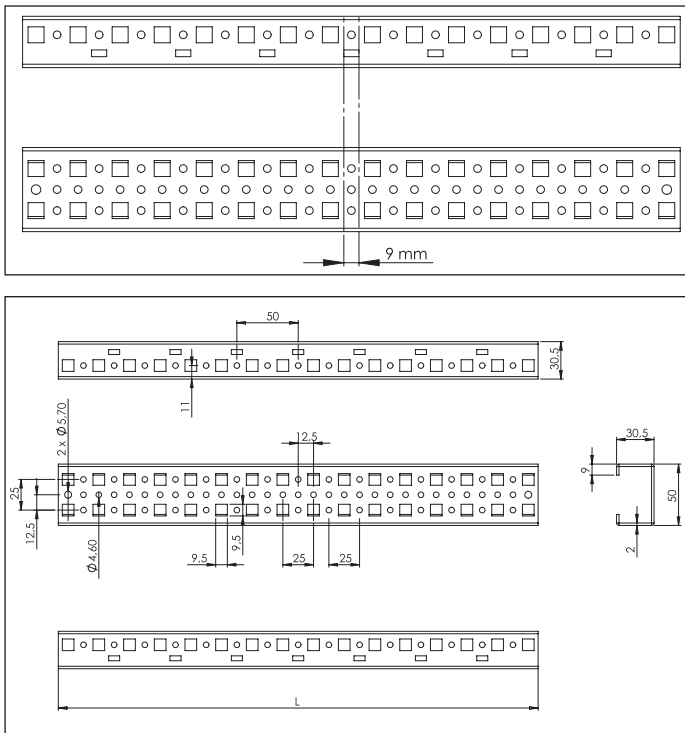

- It is designed for assembling electrical equipments into the enclosure. It is given advantages for assembling in 3D every directions.
- It is produced from 2 mm sheet thickness, thanks to this advantage and with bended structure it gives force.
- There is standard sizes, also the rail can cut to adjust required dimension.
- The rail coated zinc after production. Thanks to this coating all cutted edges protected against corrosion.
- To see using styles of rail, please see page 169-174

PRODUCT CODE	ENCLOSURE WIDTH(mm)	ENCLOSURE DEPTH (mm)	RAIL NET LENGHT (mm)	PACKS OF
944.422	ENCLOSURE WIDTH(mm)	400	291	2
944.423	ENCLOSURE WIDTH(mm)	500	391	2
944.424	ENCLOSURE WIDTH(mm)	600	491	2
944.432	ENCLOSURE WIDTH(mm)	700	591	2
944.425	ENCLOSURE WIDTH(mm)	800	691	2
944.426	ENCLOSURE WIDTH(mm)	1000	891	2
944.427	ENCLOSURE HEIGHT (mm)	1200	1091	2
944.428	ENCLOSURE HEIGHT (mm)	1600	1491	2
944.429	ENCLOSURE HEIGHT (mm)	1800	1691	2
944.430	ENCLOSURE HEIGHT (mm)	2000	1891	4
944.431	ENCLOSURE HEIGHT (mm)	2200	2091	4

MOUNTING RAIL and MOUNTING PLATE

HEAVY EQUIPMENT PROFILE

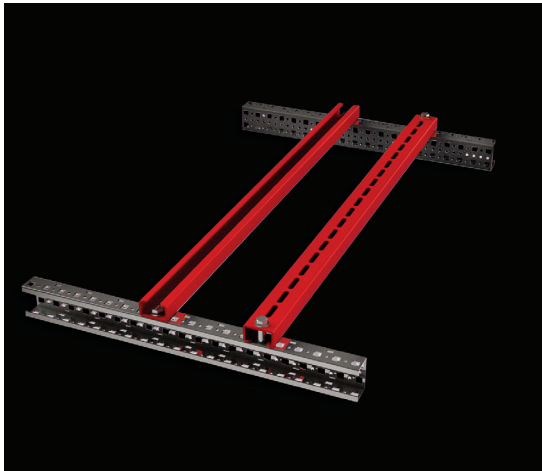

Relevance : TEOS, NEO Modular, NEO Monoblock, NEO HC Modular, NEO HC Monoblock,

Material : 3 mm Mild steel + zinc coated

Supply Includes : 2 pcs rail and assembly screws

- Used for mounting heavy equipments such as base mounting MCCB and transformer.

PRODUCT CODE	ENCLOSURE WIDTH (mm)	RAIL NET LENGTH (mm)	PACKS OF
998.540	400	360	2
998.560	600	560	2
998.570	700	660	2
998.580	800	760	2
998.510	1000	960	2

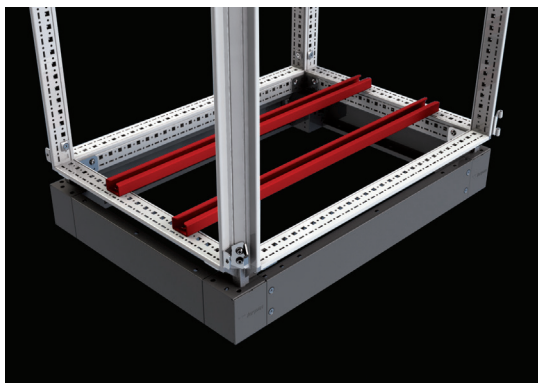

Heavy Equipment application on base

REQUIRED : It is required to fixing on frame, 4 pcs of M6 hide nut. Page 189

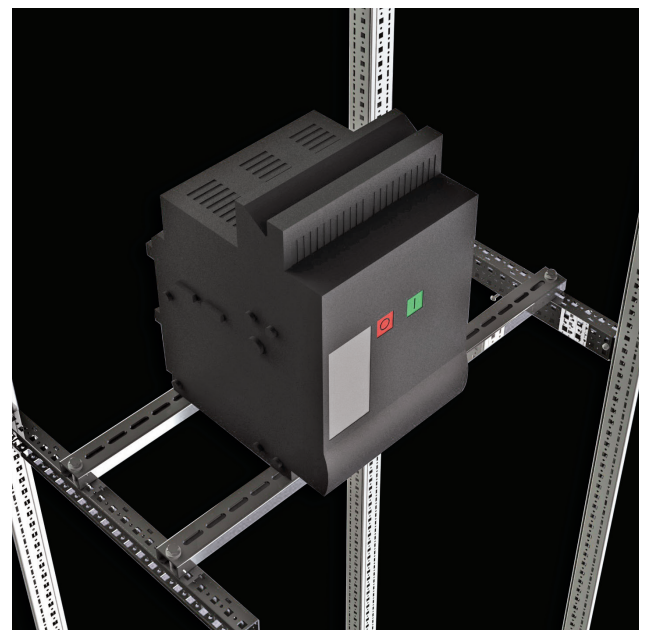

Heavy Equipment application on rails

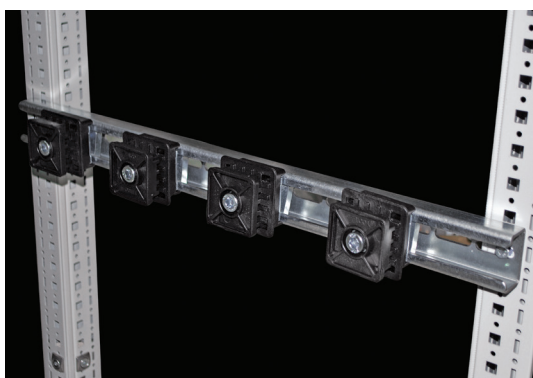

Application with adjustable flat busbar support

REQUIRED : It is required to fixing on frame, 4 pcs of M6 hide nut. Page 189

MOUNTING RAIL and MOUNTING PLATE

PLUG-IN RAIL BRACKET



Relevance : TEOS, NEO Modular, NEO Monoblock, NEO HC Modular, NEO HC Monoblock,

Material : 2 mm mild steel + zinc coated

Product Code : 944.421 (12 pcs.) (Screws included)
944.420 (100 pcs.) (Screws included)

- Thanks to this bracket, the enclosure body can be mounted, and the scissile rail can be mounted on the enclosure body. It holds tightly on the enclosure body thanks to its fitting hook. The low relief on the front surface allows for a strong profile hold on the bracket and removes the weight off the bolt.
- Recommended for profile mounting on the body.
- Moves on the profile or body at 25,00mm long steps.

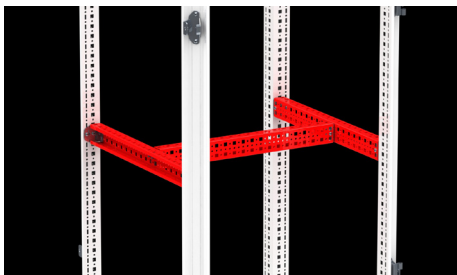
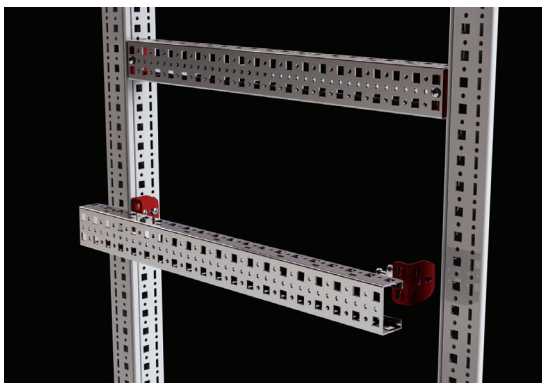

Frame width and depth combination

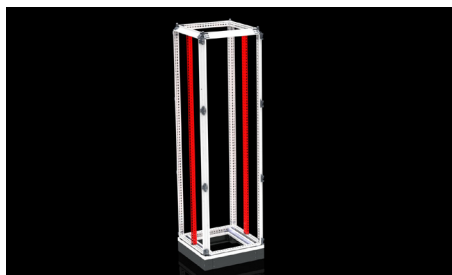

Vertical frame combination

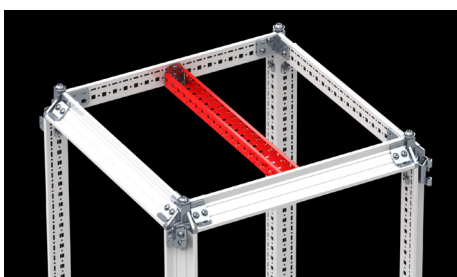

Frame top combination

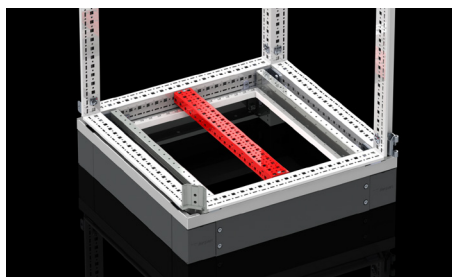

Frame bottom combination

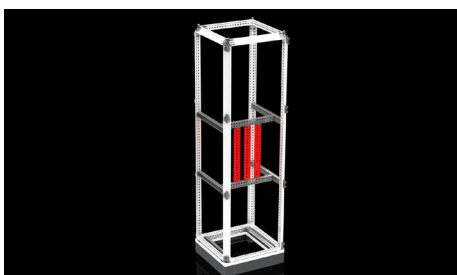

Vertical rail combination

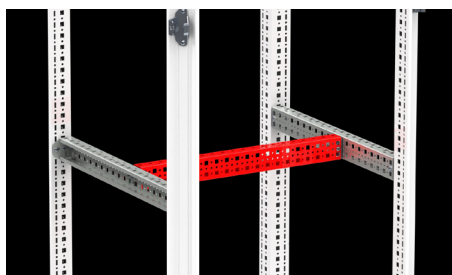

Rail width combination (horizontal)



Mounting plate combination

MOUNTING RAIL and MOUNTING PLATE

ADJUSTABLE RAIL BRACKET (TYPE T)



Relevance : TEOS, NEO Modular, NEO Monoblock, NEO HC Modular, NEO HC Monoblock,

Material : 2 mm mild steel + zinc coated

Product Code : 944.433 (4 pcs) (screws included)

- Used for mounting the scissile rail on the enclosure body.
- Its slot perforations provides the profile with a 25mm axis movement.
- The rail is able to reciprocate in vertical position. Thanks to this, the equipments mounted on the rail can be aligned to the inner panel position.
- The busbar support is used to fix the top part on the body when the rail is depth-combined on the body. See page 213
- The bulge placed on the combination part of the bracket and the rail holds the rail weight and takes the load off the screw.

25mm movement ability on the axis

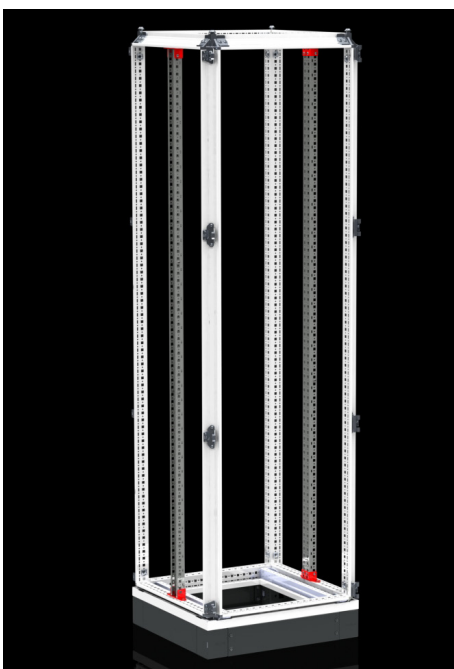
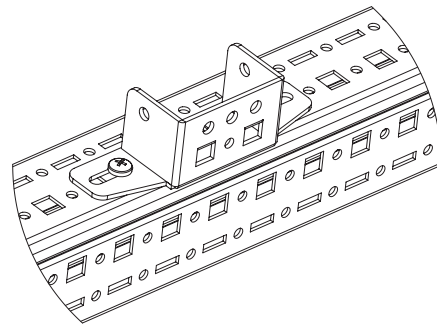
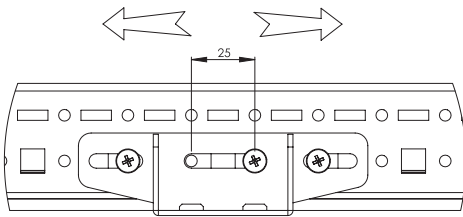

Vertical combination on the frame

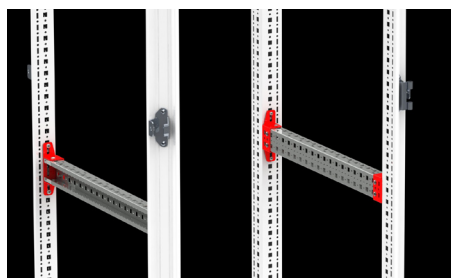

Depth combination on the frame

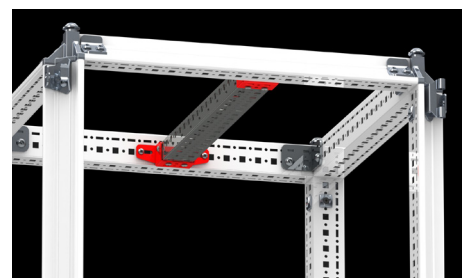

Combination on the top frame

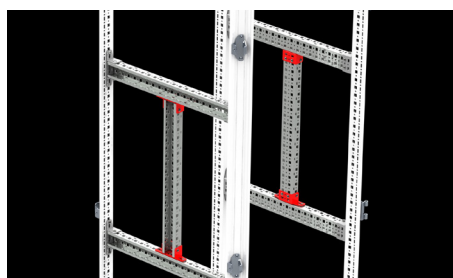

Vertical combination on the rail

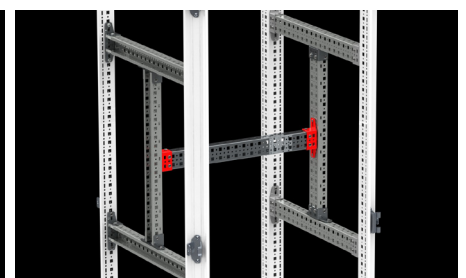

Width combination on the rail (vertical)

MOUNTING RAIL and MOUNTING PLATE

ADJUSTABLE RAIL BRACKET (TYPE L)



Relevance : TEOS, NEO Modular, NEO Monoblock, NEO HC Modular, NEO HC Monoblock,

Material : 2 mm mild steel + zinc coated

Product Code : 944.434 (4 pcs) (screws included)

- Used for mounting the scissile rail on the enclosure body.
- Its slot perforations provides the profile with a 25mm axis movement
- It is possible to adjust the equipment on the rail placed in the width position according to the inner panel.
- Positions the rail vertically on the enclosure and allows for busbar support mounting. See page 213

25mm movement ability on the axis

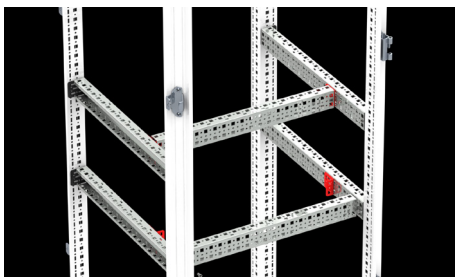
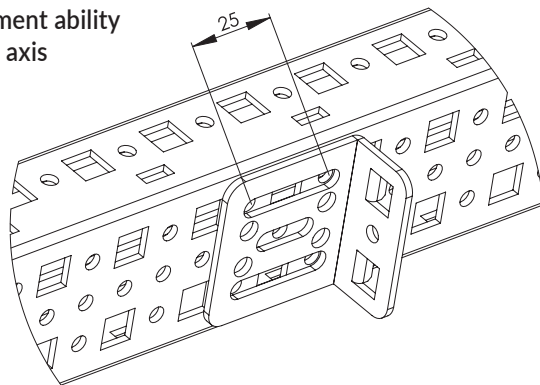

Width combination on the rail



Frame depth combination

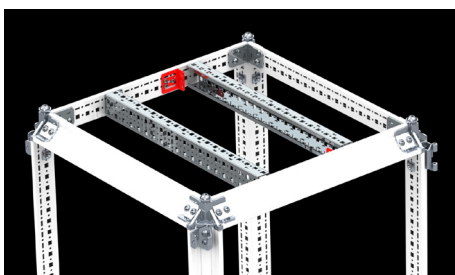

Frame top combination (vertical)

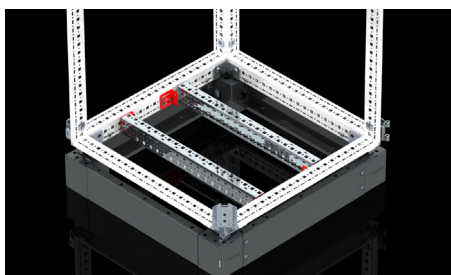

Frame bottom combination (vertical)

MOUNTING RAIL and MOUNTING PLATE

25A - 630A MCCB KIT (TEOS, NEO Modular, NEO Monoblock, NEO HC Modular, NEO HC Monoblock)

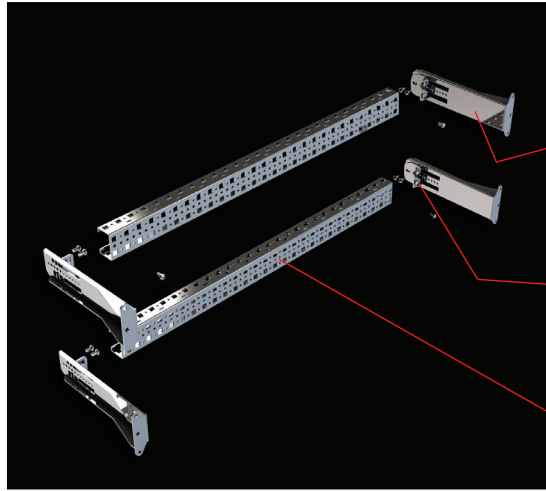

Relevance : TEOS, NEO Modular, NEO Monoblock, NEO HC Modular, NEO HC Monoblock,

○ 4x Kit Bracket

Material : 2 mm mild steel + zinc coated
Product Code : 944.436 (2 pcs.) (Screws included)

○ 4 x Plug-in Rail Bracket

Product Code : 944.420 (100 pcs.) (Screws included)
944.421 (12 pcs) (Screws included)

○ 2x Scissile Width Rail



○ 1x Part Mounting Plate

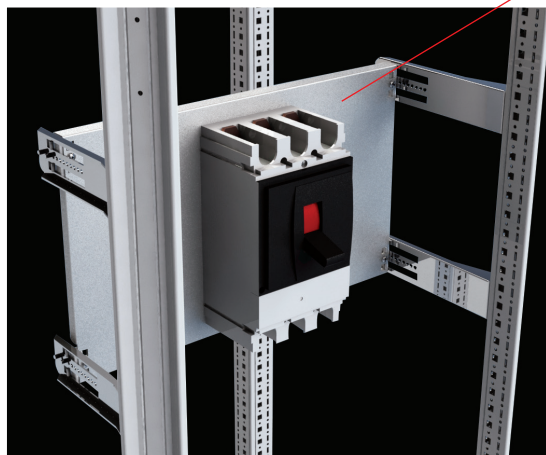

PRODUCT CODE	ENCLOSURE WIDTH (W) (mm)	RAIL NET LENGHT (mm)	PACKS OF
944.422	400	291	2
944.424	600	491	2
944.432	700	591	2
944.425	800	691	2

- This is the kit which enables compact MCCB (from lowest upto 630 Amperes) mounting.
- As mounted from the front part of the enclosure, it makes it possible for a copper busbar installation by creating space at the back of the enclosure
- Enables strong mounting with the plug-in rail bracket, and 7,00mm reciprocating motion ability.
- Offers a more economical solution as it eliminates the use of an entire depth rail.
- It is accord with cover plate.

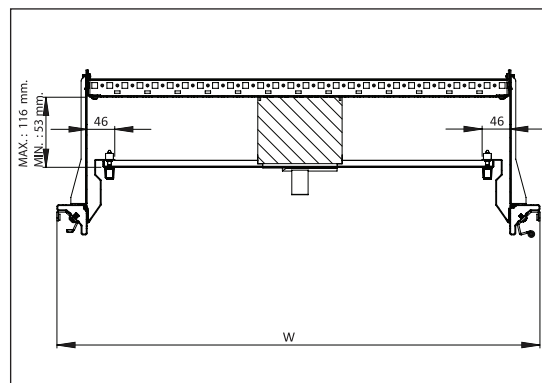

MOUNTING RAIL and MOUNTING PLATE

MCB AND TERMINAL KIT (BACK-MOUNTED CABLE DUCT)

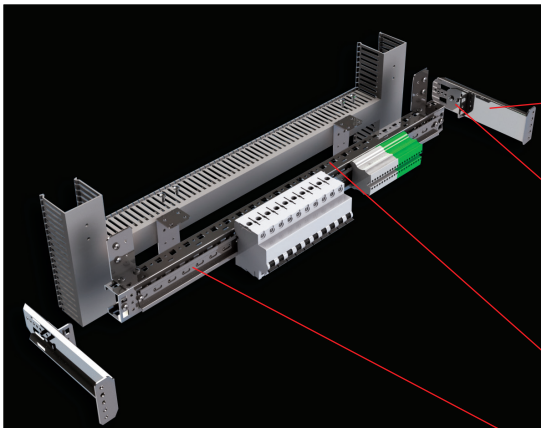

Relevance : TEOS, NEO Modular, NEO Monoblock,
NEO HC Modular, NEO HC Monoblock,

○ 2x Kit Bracket

Material : 2 mm mild steel + zinc coated
Product Code : 944.436 (2 pcs.) (Screws included)

○ 2x Plug-in rail bracket

Product Code : 944.420 (100 pcs.) (Screws included)
944.421 (12 pcs.) (Screws included)

○ 1x scissile width rail



○ 1x terminal / MCB rail H7,5 mm (2 meters)

Product Code : 990.102 (1 pcs.)

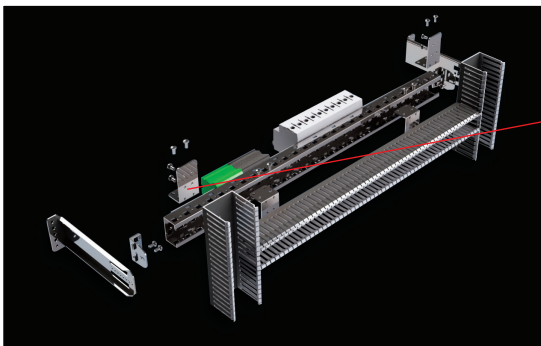

○ 3x duct bracket

Material : 2 mm mild steel + zinc coated
Product Code : 944.437 (12 pcs.) (Screws included)



- Mounts MCBs and terminals on the front enclosure panel without depth profiles.
- Enables to connect cable ducts from the rear for MCB mountings and mount a maximum number of MCBs.
- Suitable size: 60x60mm for vertical ducts and 40x60mm for horizontal cable duct layings
- Mounted on the enclosure body, the mounting kits are designed with 7,00mm stepping perforations and enable mounting both on the MCBs and the terminal boxes.
- Maximum number of MCBs on the mounting rail:

Enclosure Width	MCB Capacity
400	10
600	22
700	28
800	34

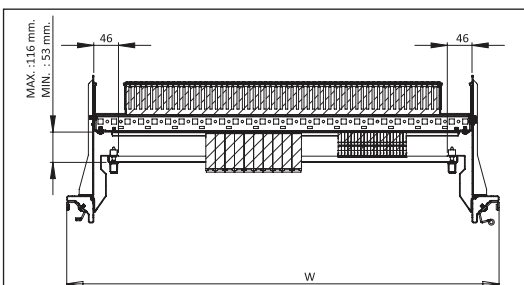

MOUNTING RAIL and MOUNTING PLATE

MCB KIT (FRONT-MOUNTED CABLE DUCT)

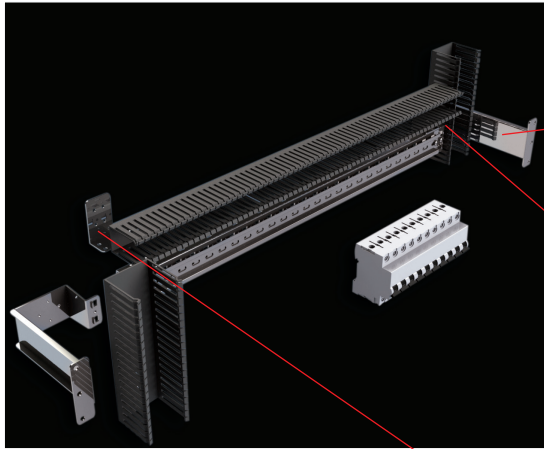

Relevance : TEOS, NEO Modular, NEO Monoblock,
NEO HC Modular, NEO HC Monoblock,

○ 2x MCB kit:

Material : 2 mm mild steel + zinc coated
Product Code : 944.478 (2 pcs.) (Screws included)

○ 1x Scissile width MCB rail.

PRODUCT CODE	ENCLOSURE WIDTH (mm)	RAIL NET LENGHT (mm)	PACKS OF
944.439	600	341	1
944.440	700	441	1
944.441	800	541	1

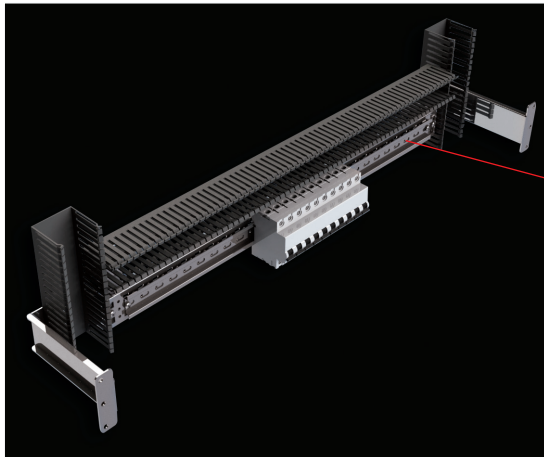

○ 2x duct bracket

Material : 2 mm mild steel + zinc coated
Product Code : 944.437 (12 pcs.) (Screws included)

○ 1x terminal / MCB rail H7,5 mm (2 meters)

Product Code : 990.102 (1 pcs.)

- Mounts the MCBs on the front enclosure body without depth rails.
- Cable ducts can be connected from the front for MCB mountings.
- Suitable size: 60x60mm for vertical cables and 40x60mm for horizontal cable duct layings.
- Maximum number of MCBs on the mounting rail:

Enclosure Width	MCB Capacity
400	5
600	16
700	22
800	28

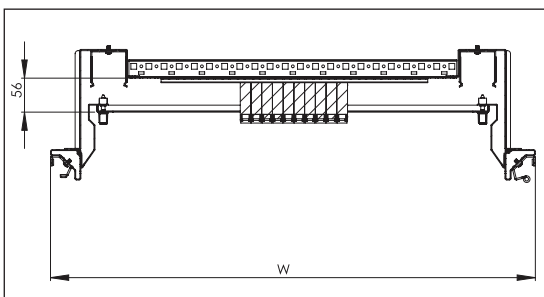

SHELF and INTERIOR PARTS

DIVIDING PANEL

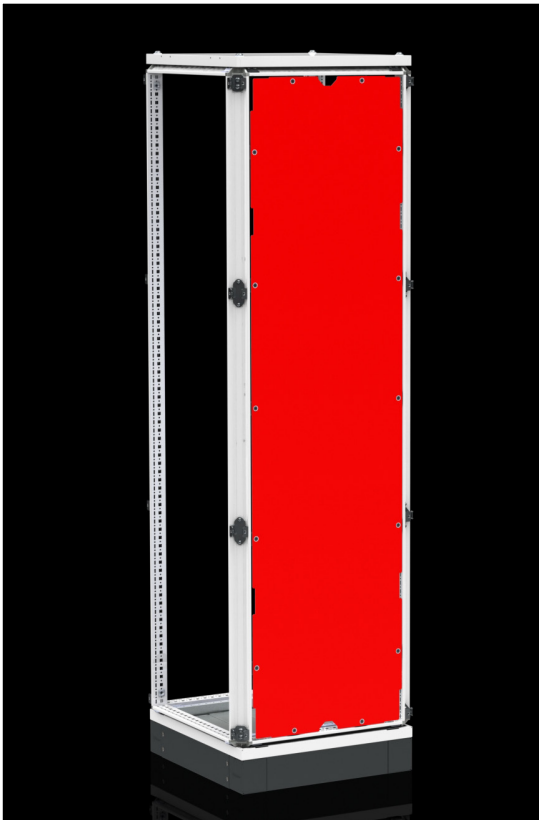

Relevance : TEOS

Material : 1,5 mm Galvanised + RAL 7035 coating

Supply Includes : 1 pcs panel and assembling parts.

- Used for separating enclosures and mounting applications.

TEOS ENCLOSURE		
Product Code.	HEIGHT (mm)	DEPTH (mm)
935.001	1800	400
935.002	1800	500
935.003	1800	600
935.004	1800	800

TEOS ENCLOSURE		
Product Code.	HEIGHT (mm)	DEPTH (mm)
935.005	2000	400
935.006	2000	500
935.007	2000	600
935.008	2000	800
935.009	2200	600

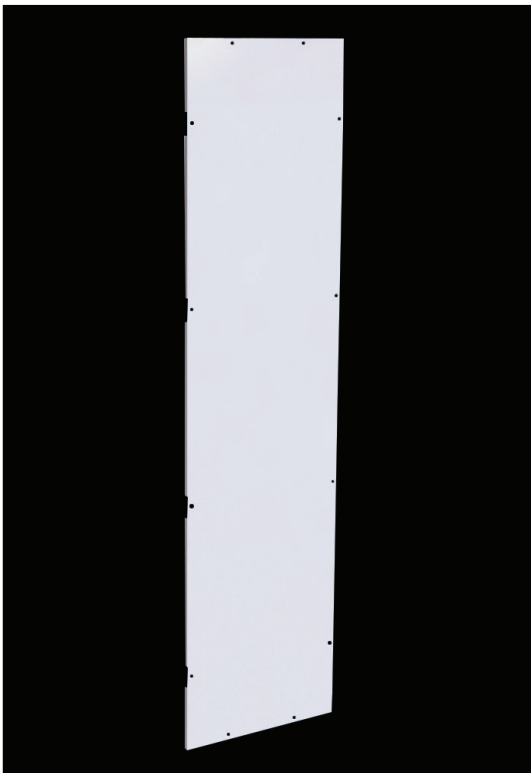

DIVIDING PANEL

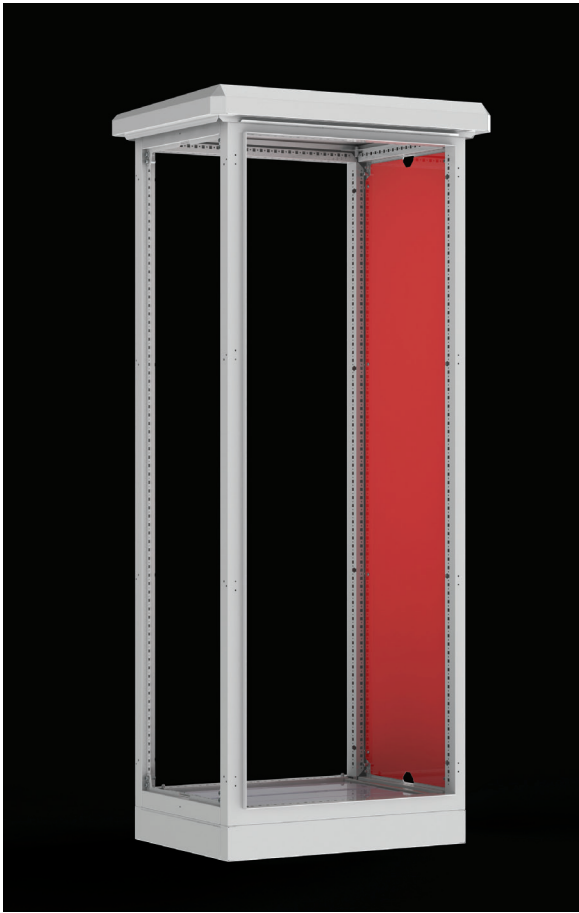

Relevance : NEO Monoblock, NEO Modular,
NEO HC Modular, NEO HC Monoblock

Material : 1,5 mm Mild steel + RAL 7035 coating

Supply Includes : 1 Pcs panel ve assembly parts

- Used for separating enclosures and mounting applications.

PRODUCT CODE	Height (H) mm	Depth (D) mm
936.184	1800	400
936.185	1800	500
936.186	1800	600
936.204	2000	400
936.205	2000	500
936.206	2000	600
936.208	2000	800

SHELF and INTERIOR PARTS

DOOR RAIL FOR CABLE DUCT



Relevance : TEOS, NEO Modular, NEO Monoblock,
NEO HC Modular, NEO HC Monoblock

Related size : ENCLOSURE WIDTH

Material : 2,00 mm mild steel + zinc-coated

Supply Includes : 1 pcs door rail and assembling parts.

ATTENTION : 2 pcs of door channel profile accessory needed for 800 mm, 1000 mm and 1200mm wide double doors.

PRODUCT CODE	ENCLOSURE WIDTH (mm)
997.104	400 single door
997.113	600 single door
997.116	700 single door
997.114	800 single door
997.118	800 double door
997.111	1000 single door
997.115	1000 double door
997.112	1200 double door

METAL PLAN POCKET

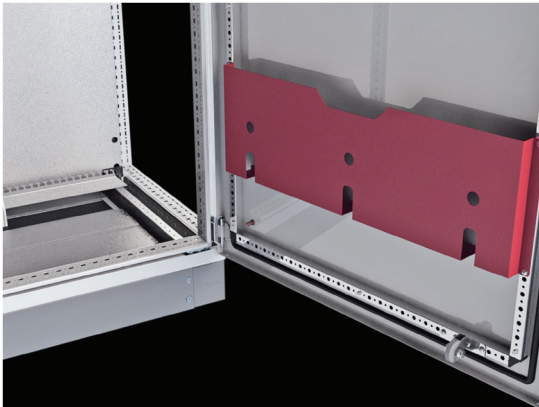

Relevance : TEOS, NEO Modular, NEO Monoblock,
NEO HC Modular, NEO HC Monoblock

Related size : ENCLOSURE WIDTH

Material : 1,50 mm mild steel + RAL 7035 powder-coating

Supply Includes : 1 pcs metal plan pocket and assembling parts

PRODUCT CODE	ENCLOSURE WIDTH (mm)
994.704	400 single door
994.706	600 single door
994.707	700 single door
994.708	800 single door
994.711	1000 single door
994.710	1000 double door

DOOR STOPPER



Relevance : TEOS

- It is using for angle limitation door.

Product Code : 905.202 door stopper (right)
905.203 door stopper (left)

DOOR STOPPER

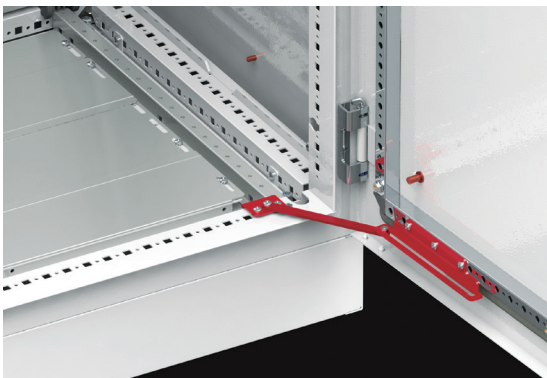

Relevance : NEO Modular, NEO Monoblock,
NEO HC Modular, NEO HC Monoblock

- It is using for angle limitation door.

Product Code : 905.204 door stopper

SHELF and INTERIOR PARTS

LAMP RAIL

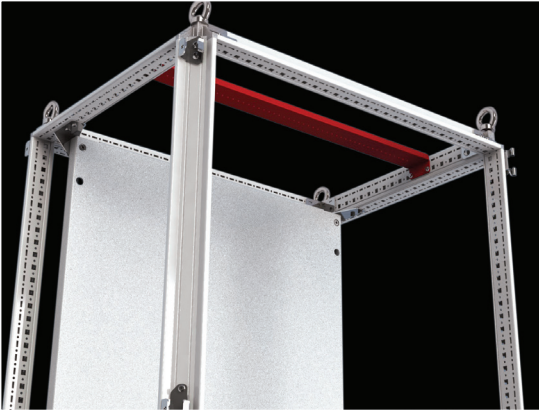

Relevance : TEOS, NEO Modular, NEO Monoblock,
NEO HC Modular, NEO HC Monoblock

Related size : ENCLOSURE WIDTH

Material : 2,00 mm mild steel + zinc-coated

Supply Includes : 1 pcs lamp bracket rail and assembling parts

PRODUCT CODE	ENCLOSURE WIDTH (mm)
903.204	400
903.206	600
903.207	700
903.208	800
903.210	1000
903.212	1200

SWITCH BRACKET

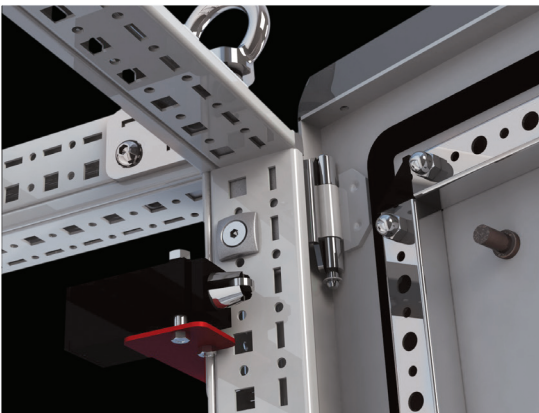

Relevance : TEOS, NEO Modular, NEO Monoblock,
NEO HC Modular, NEO HC Monoblock

Material : 2,00 mm mild steel + zinc-coated

Supply Includes : 1 pcs switch bracket and assembling parts

Product Code : 903.300

TEOS AND NEO INTERIOR COVER PLATE SYSTEM



- For covering off the electrical equipment from the front of enclosure
- It is modular structure and can be selected as whole or partly.
- Partial covers are with hinges

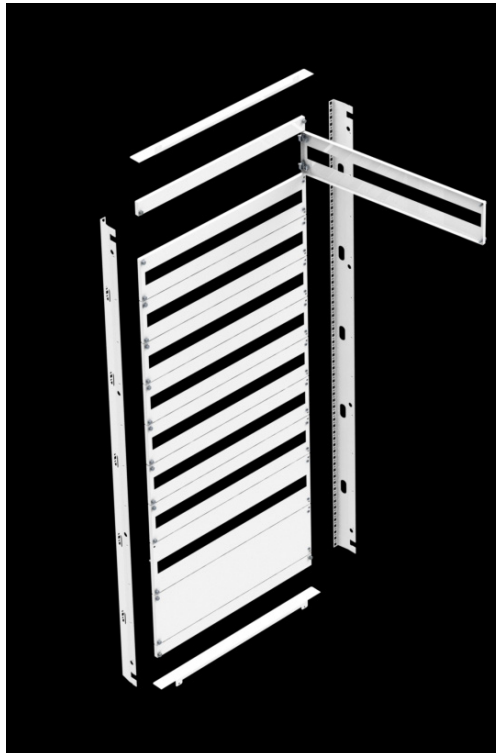
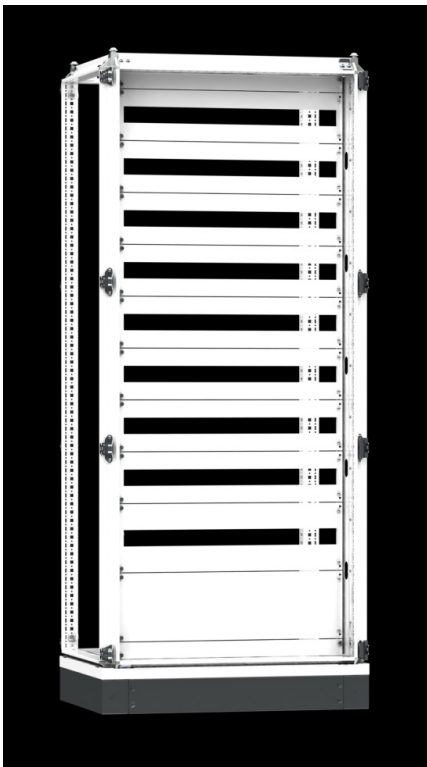

INTERIOR COVER PLATE

COVER PLATE FRAME SET



Relevance : TEOS, NEO Modular, NEO Monoblock, NEO HC Modular, NEO HC Monoblock

Material : 1,50 mm mild steel + RAL 7035 powder coating

Supply Includes : 2 pcs vertical profile, 2 pcs bottom-top closer, 2 pcs bottom-top cover plate, 4 pcs cable protection and assembly parts.

ATTENTION : You can find the size of the vertical inner panel profile in the drawing and table. Cover plate sizes will be determined according to this size

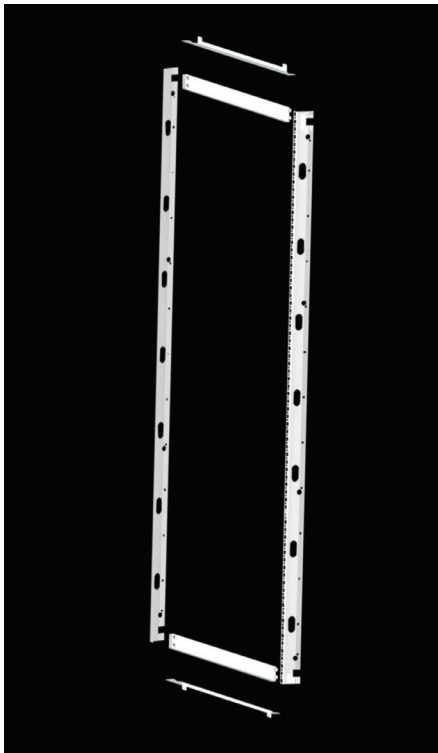

PRODUCT CODE	ENCLOSURE WIDTH (W)	ENCLOSURE HEIGHT (H)	COVER FRAME NET HEIGHT (H1) (mm)
953.401	400	1800	1600
953.402	400	2000	1800
953.403	600	1200	1000
953.404	600	1600	1400
953.405	600	1800	1600
953.406	600	2000	1800
953.408	700	2000	1800
953.409	800	1200	1000
953.410	800	1600	1400
953.411	800	1800	1600
953.412	800	2000	1800
953.465	1000	1800	1600
953.466	1000	2000	1800

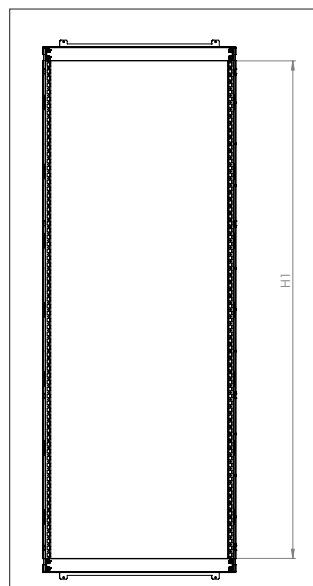

COVER PLATE



Relevance : TEOS, NEO Modular, NEO Monoblock,
NEO HC Modular, NEO HC Monoblock

Material : 1,50 mm mild steel + RAL 7035 powder coating

Supply Includes : 1 pcs cover plate and mounting parts

IMPORTANT : The usable size of the inner lid length profile (inner lidnet height H1) is shown in the drawing and on the table. The inner lid will be determined according to this measure.

NECESSARY : To fix the interior cover plate, the appropriate interior cover frame set is required for the board size. See page 181

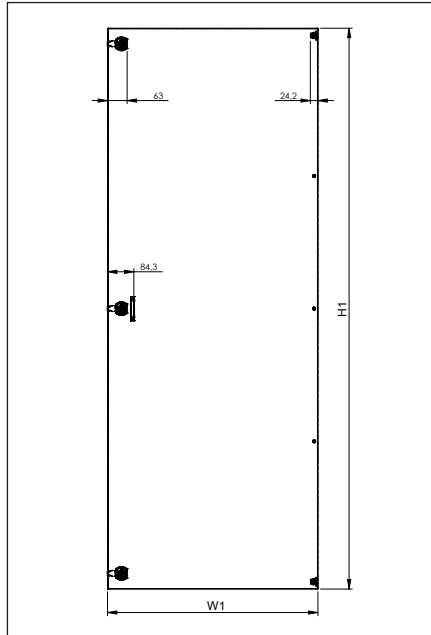

PRODUCT CODE	ENCLOSURE WIDTH (W)	ENCLOSURE NET HEIGHT (W1)	PLATE NET HEIGHT (H1)	INTERIOR COVER PLATE NET HEIGHT
713.418	400	1800	273	1597
713.420	400	2000	273	1797
713.612	600	1200	473	997
713.616	600	1600	473	1397
713.618	600	1800	473	1597
713.620	600	2000	473	1797
713.720	700	2000	573	1797
713.812	800	1200	673	997
713.816	800	1600	673	1397
713.818	800	1800	673	1597
713.820	800	2000	673	1797

INTERIOR COVER PLATE

PARTIAL COVER PLATE

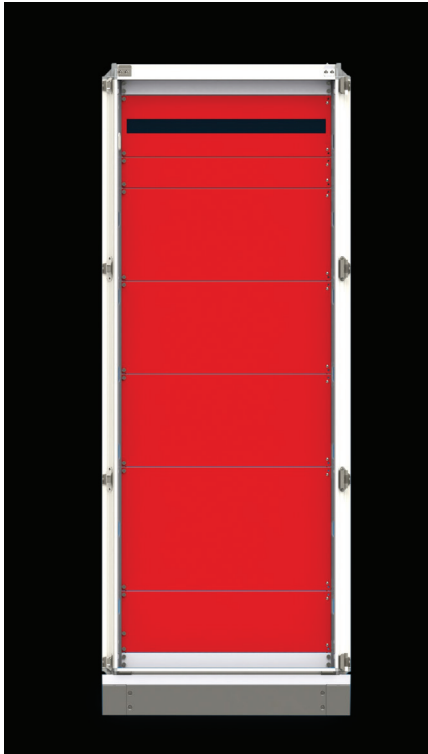

Relevance : TEOS, NEO Modular, NEO Monoblock, NEO HC Modular, NEO HC Monoblock

Material : 1,50 mm mild steel, RAL 7035

Supply Includes : 1 pcs cover plate and assembling parts

NECESSARY : To fix the interior cover plate, the appropriate interior cover frame set is required for the board size. See page 181

PRODUCT CODE	ENCLOSURE WIDTH (W)	PLATE NET WIDTH (W1)	PLATE NET HEIGHT (H1)	MCB QTY
954.405	400	273	50	-
954.410			100	-
954.415			150	-
954.416			150 W	12
954.420			200	-
954.421			200 W	12
954.425			250	-
954.430			300	-
954.431			300 W	12
954.435			350	-
954.440			400	-
954.450			500	-
954.460			600	-
954.605	600	473	50	-
954.610			100	-
954.615			150	-
954.616			150 W	24
954.620			200	-
954.621			200 W	24
954.625			250	-
954.630			300	-
954.631			300 W	24
954.635			350	-
954.640			400	-
954.650			500	-
954.660			600	-
954.705	700	573	50	-
954.710			100	-
954.715			150	-
954.716			150 W	30
954.720			200	-
954.721			200 W	30
954.725			250	-
954.730			300	-
954.731			300 W	30
954.735			350	-
954.740			400	-
954.750			500	-
954.760			600	-
954.805	800	673	50	-
954.810			100	-
954.815			150	-
954.816			150 W	36
954.820			200	-
954.821			200 W	36
954.825			250	-
954.830			300	-
954.831			300 W	36
954.835			350	-
954.840			400	-
954.850			500	-
954.860			600	-

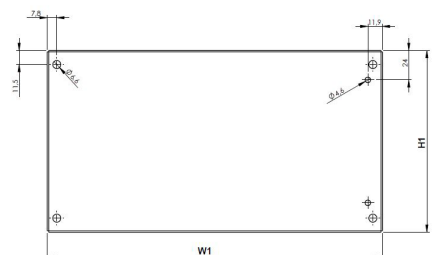
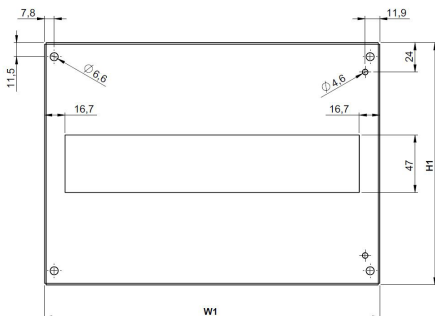

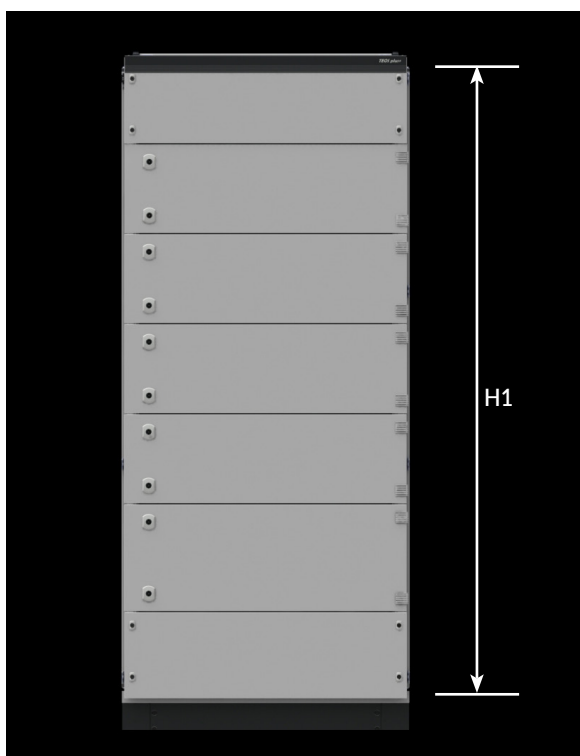
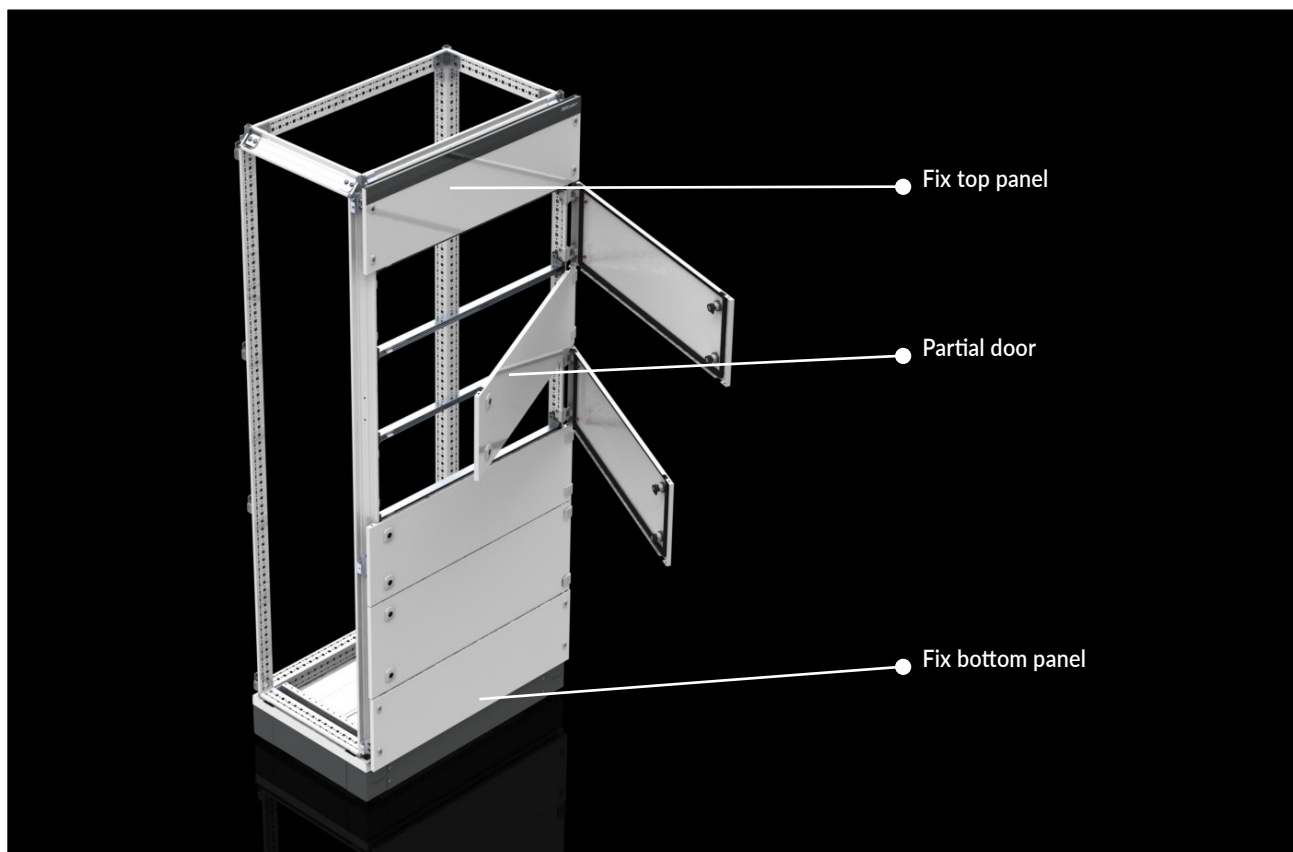

ENCLOSURE HEIGHT (H)	AVAILABLE NOMINAL HEIGHT (H1)
1200	1100
1600	1500
1800	1700
2000	1900
2200	2100

IMPORTANT : 1 piece of fixed top cover and 1 piece of fixed bottom cover shall be chosen for each enclosure.

IMPORTANT : The sum of the door heights must match the available nominal height (H1).

PARTIAL DOOR SYSTEM

PARTIAL FRONT DOOR

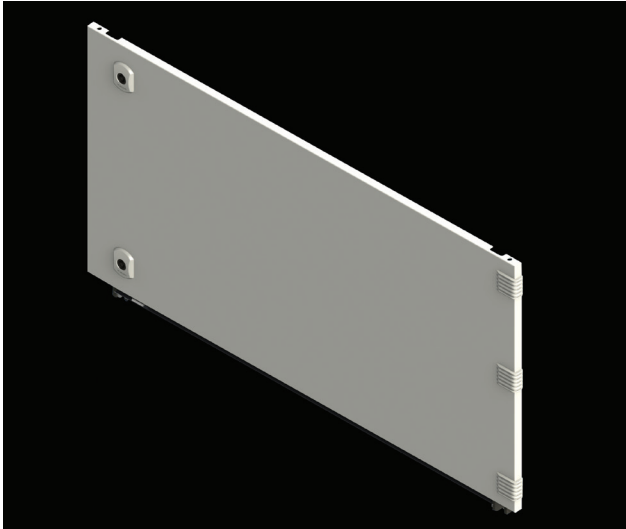

Relevance : TEOS
Material : 1,50 mm mild steel + RAL 7035 powder coating
Supply Includes : 1 pcs partial door,
 1 piece door splitting profile and fittings.

PRODUCT CODE	ENCLOSURE WIDTH (W)	DOOR HEIGHT
853.415	400	150
853.420	400	200
853.425	400	250
853.430	400	300
853.435	400	350
853.440	400	400
853.445	400	450
853.450	400	500
853.460	400	600
853.480	400	800
853.410	400	1000
853.615	600	150
853.620	600	200
853.625	600	250
853.630	600	300
853.635	600	350
853.640	600	400
853.645	600	450
853.650	600	500
853.660	600	600
853.680	600	800
853.610	600	1000
853.815	800	150
853.820	800	200
853.825	800	250
853.830	800	300
853.835	800	350
853.840	800	400
853.845	800	450
853.850	800	500
853.860	800	600
853.880	800	800
853.810	800	1000

PARTIAL FIX PANEL(TOP)



Relevance : TEOS
Material : 1,50 mm mild steel+ RAL 7035 powder coating
Supply Includes : 1 pcs partial fix panel,
 1 piece tac profile,
 1 piece door splitting profile and fittings.

PARTIAL FIX PANEL(BOTTOM)

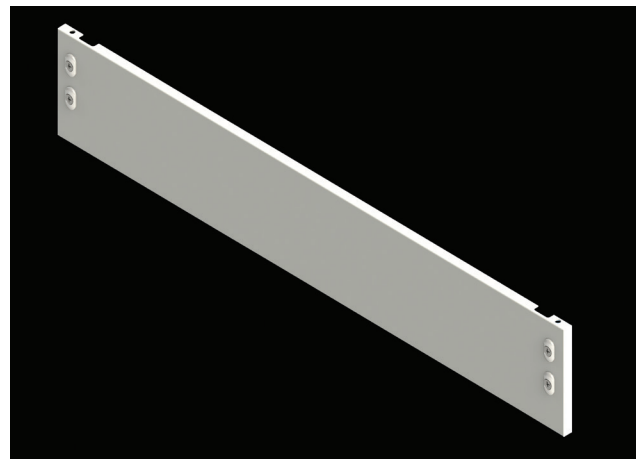

Relevance : TEOS
Material : 1,50 mm mild steel+ RAL 7035 powder coating
Supply Includes : 1 pcs partial fix panel and assembling parts.

TOP PANEL PRODUCT CODE	BOTTOM PANEL PRODUCT CODE	ENCLOSURE Width(W)	DOOR HEIGHT
854.410	855.410	400	100
854.420	855.420	400	200
854.610	855.610	600	100
854.620	855.620	600	200
854.810	855.810	800	100
854.820	855.820	800	200

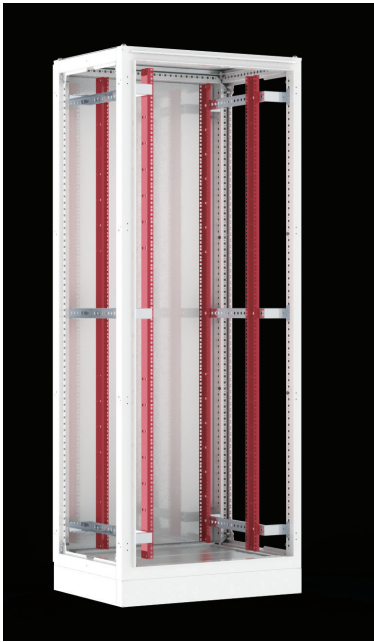

19" COMBINATION PROFILES

Relevance : TEOS, NEO Modular, NEO Monoblock, NEO HC Modular, NEO HC Monoblock

Material : 2,00 mm mild steel+ zinc-plating

Supply Includes : 4 pcs profile and combination screws

REQUIRED : 6 pcs scissile rail for 600mm width enclosure applications on depth side of enclosure. In 800 mm width enclosures, 6 pcs 800 mm width adapter requires. See page 186

PRODUCT CODE	ENCLOSURE HEIGHT(H)	UNIT U
944.930	1200	24
944.931	1600	33
944.932	2000	42

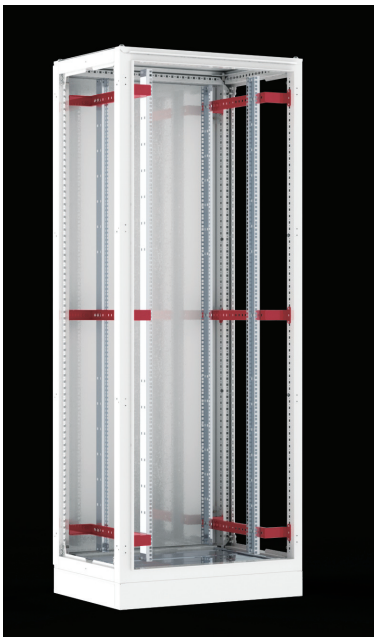

800 mm WIDTH ADAPTER (19")

Relevance : TEOS, NEO Modular, NEO Monoblock, NEO HC Modular, NEO HC Monoblock

Material : 2,00 mm mild steel+ zinc-plating

Supply Includes : 6 pcs adapter and assembling parts.

Product Code : Enclosure depth: 600 mm: **944.933**
Enclosure depth: 800 mm: **944.934**

MOUNTING ACCESSORIES

19" SWING FRAME

Relevance : TEOS, NEO Modular, NEO Monoblock,
NEO HC Modular, NEO HC Monoblock

Material : 2,00 mm mild steel + RAL 7035 coating

Supply Includes : 1 set of swing frame
(lock-hinges included)



PRODUCT CODE	ENCLOSURE		
	WIDTH (W)	HEIGHT (H)	UNIT U
944.935	600	1200	22
944.936	600	1600	31
994.937	600	1800	36
944.938	600	2000	40
994.939	600	2200	45
944.940	800	1200	22
944.941	800	1600	31
944.942	800	1800	36
944.943	800	2000	40
944.944	800	2200	45

FIXED and MOVABLE SHELF

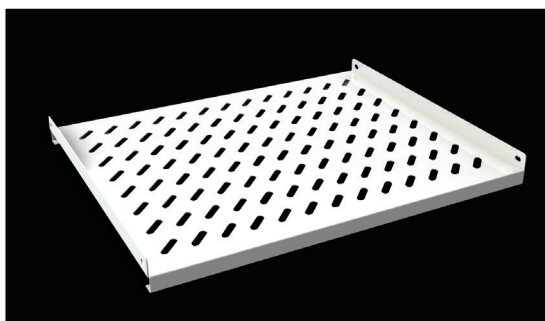

Relevance : TEOS, NEO Modular, NEO Monoblock, NEO HC Modular, NEO HC Monoblock

Material : 1,50 mm mild steel+RAL 7035 coating

Supply Includes : 1 pcs shelf and combination parts.
It may be used with Rails.

REQUIRED : According to depth of enclosures, a pair of depth rail and 4 rail barckets are needed.

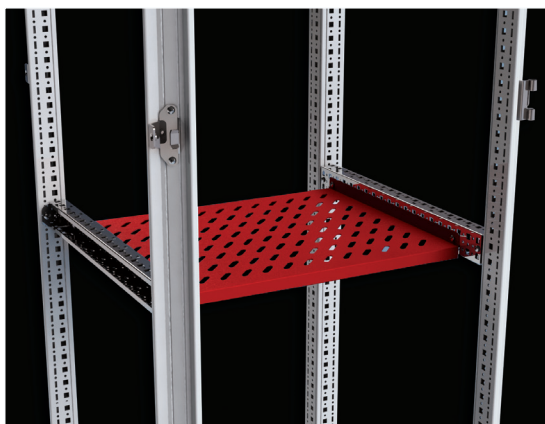

PRODUCT CODE	ENCLOSURE	
	WIDTH (mm)	DEPTH (mm)
FIXED SHELF IN FULL SIZE		
945.200	600	600
945.201		800
MOVABLE SHELF IN FULL SIZE		
945.400	600	600
945.401		800
FIXED SHELF IN 19" SYSTEM		
945.204		600
945.205		800
MOVABLE SHELF IN 19" SYSTEM		
945.404		600
945.405		800



PRODUCT CODE	ENCLOSURE	
	WIDTH (mm)	DEPTH (mm)
FIXED SHELF IN FULL SIZE		
945.202	800	600
945.203		800
MOVABLE SHELF IN FULL SIZE		
945.402	800	600
945.403		800



KNITTED EARTHING CABLE

Material : Copper + tin-plating

Supply Includes : 5 pcs cable and screws

Product Code : 991.202 (5 pcs)
991.204 (1 pcs)



M6 HIDE NUT

- Necessary for installing the support and mounting rails on the enclosure. Installed from square perforations placed on the front surface of closed profiles.

Product Code : 994.170 (100 pcs packs)
994.171 (10 pcs packs)



COMFORT LOCKING HANDLE & INSERTS

Relevance : TEOS,

Product Code :

COMFORT Locking Handle with 5333 insert : 950.103

Insert Doublebit 5,00mm : 950.250

Insert Triangle 9,00mm : 950.252

Insert Square 8,00mm : 950.251

NECESSARY : In the case of selecting of the other lock inserts (Doublebit , Triangle and Square), the corresponding key must also be selected.



COMFORT LOCKING HANDLE & INSERTS

Relevance : NEO Modular, NEO Mb

Reference no :

COMFORT Locking Handle with 5333 insert : 950.117

COMFORT Locking Handle (PAD LOCK) with 5333 insert : 951.214

Insert Doublebit 5,00mm : 950.110

Insert Triangle 9,00mm : 950.115

Insert Square 8,00mm : 950.116

NECESSARY : In the case of selecting of the other lock inserts (Doublebit , Triangle and Square), the corresponding key must also be selected.

KEYS



Relevance : All Lock Systems
Material : Zamak + Zinc-Coating
Supply : Key 1 pcs
Includes : Eurokey 2 pcs

PRODUCT CODE	MODEL
952.101	5 mm Double-bit
952.102	8 mm Square
952.103	9 mm Triangular
952.300	Eurokey (5333)